



V-BELT PULLEYS

V-BELT PULLEYS FOR TAPER BUSHES

SPZ	page 5
SPA	9
SPB	13
SPC	18

V-BELT PULLEYS PILOT BORE

SPA	23
SPB	25
SPC	28

V-BELT PULLEYS FOR LOCKING DEVICES

SPA	30
SPB	31
SPC	33

ADJUSTABLE V-BELT PULLEY PRB TYPE	34
--	----

V-BELT PULLEYS PPV-J MICRO V	39
-------------------------------------	----

V-BELT PULLEYS PPV-L MICRO V	40
-------------------------------------	----



CAST- IRON V-BELT PULLEYS

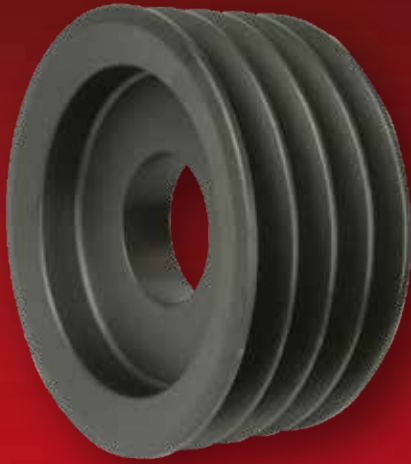



CAST- IRON V-BELT PULLEYS

All V-belt pulleys are compliant with current legislation and are made of cast iron **GG 20** with protective phosphate.

Running in normal standard, the pulleys are statically balanced and this is sufficient for peripheral speeds up to **25 m/s**.

For higher speeds is essential dynamic balancing can be provided on request.

The Chiaravalli Group SpA is able to perform, upon request, balancing pulleys with diameters up to 630, with balancing CNC, accompanying certificate of balancing performed.

Over 35 m / sec, the pulleys in cast iron are not the most suitable and it requires the use of high-strength material.

D = diameter in meters

N = number of revolutions per minute

$$V_p = \frac{\pi \cdot D \cdot n}{60} = \frac{D \cdot n}{19,1} \text{ m/sec.}$$

Dimensions shown on the dimensional tables are not binding even if they are respected as far as possible.

We reserve the right to make variations and modifications without prior notice.

FEATURES OF THE GORGE

PROFILE	Dp mm	a°	W pg	g	h	b mm	f	e
SPZ	< 80	34°	8,5	9,7	9	2	8	12
	> 80	38°						
SPA	< 118	34°	11	12,7	11	2,8	10	15
	> 118	38°						
SPB	< 190	34°	14	16,3	14	3,5	12,5	19
	> 190	38°						
SPC	< 315	34°	19	22,0	19	4,8	17	25,5
	> 315	38°						

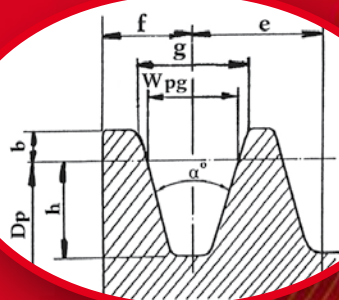

BAND WIDTH

N° GROOVES	SPZ	SPA	SPB	SPC
1	16	20	25	34
2	28	35	44	59,5
3	40	50	63	85
4	52	65	82	111
5	64	80	101	136
6		95	120	162
8			158	213
10			196	264

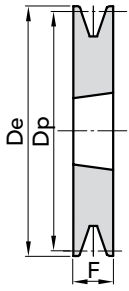

EXEC. 1

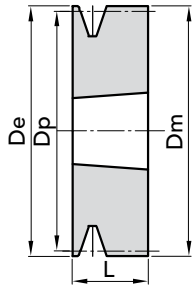

EXEC. 2

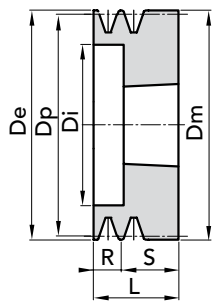

EXEC. 3

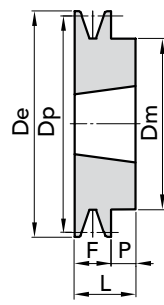

EXEC. 4

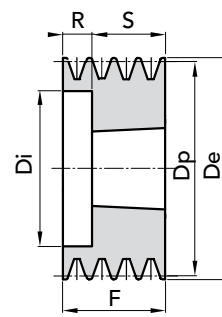

EXEC. 5

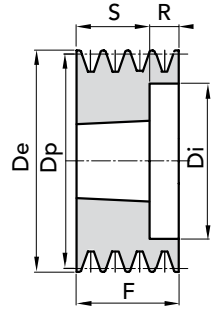

EXEC. 6

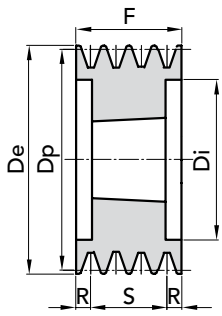

EXEC. 7

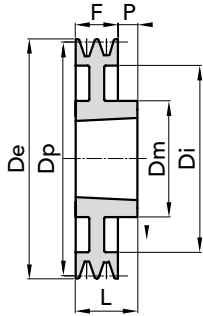

EXEC. 8

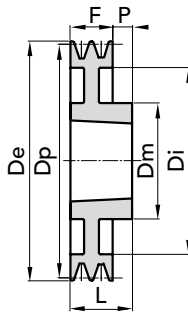

EXEC. 8A

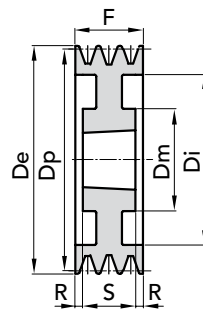

EXEC. 9

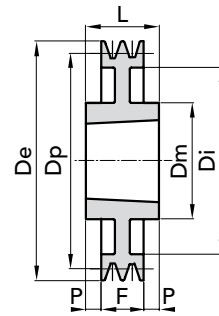

EXEC. 10

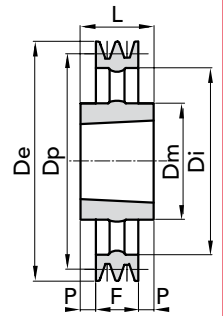

EXEC. 11

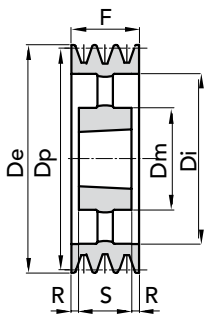

EXEC. 12

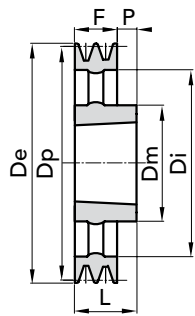

EXEC. 13

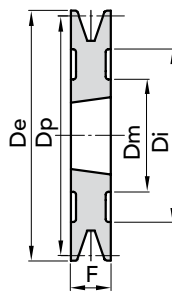

EXEC. 14

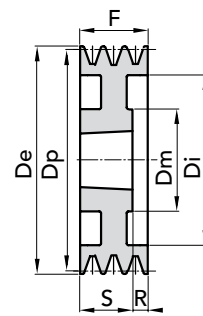

EXEC. 15

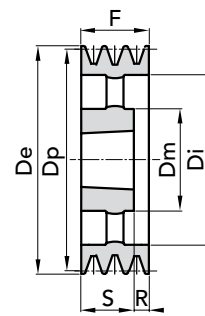

EXEC. 16

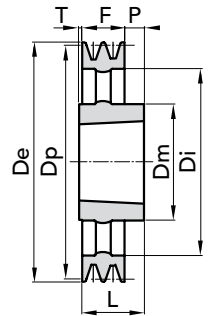

EXEC. 17



TAPER BUSHES

SPZ TYPE

We are engaged to respect shapes and dimensions shown on this sheet but, we reserve the right to make changes and modifications without notice.

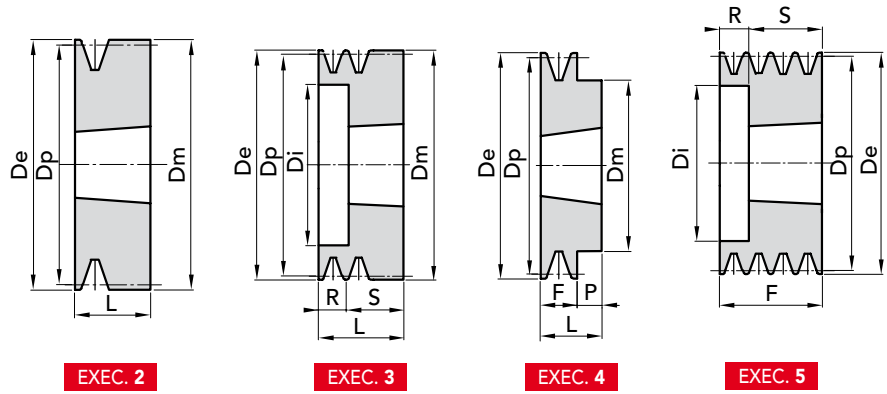

V-BELT PULLEYS for TAPER BUSHES

Dp	P. NUMBER	N°	EXEC.	BUSHE	Ø De	Ø Di	Ø Dm	F	L	P	R	S	WEIGHT
GROOVES													
Kg.													
60	91100601	1	2	1108	64,6		64,6		22				0,50
	91100602	2	3	1108	64,6	36	64,6		49		27	22	0,60
63	91100631	1	4	1108	67,6		62	16	22	6			0,40
	91100632	2	5	1108	67,6	40		28			6	22	0,50
	91100633	3	5	1108	67,6	40		40			18	22	0,50
67	91100671	1	4	1108	71,6		62	16	22	6			0,50
	91100672	2	5	1108	71,6	42		28			6	22	0,50
	91100673	3	5	1108	71,6	42		40			18	22	0,70
71	91100711	1	4	1108	75,6		62	16	22	6			0,50
	91100712	2	5	1108	75,6	42		28			6	22	0,50
	91100713	3	5	1108	75,6	42		40			18	22	0,70
75	91100751	1	4	1108	79,6		62	16	22	6			0,60
	91100752	2	5	1210	79,6	51		28			3	25	0,60
	91100753	3	5	1210	79,6	48		40			15	25	0,80
80	91100801	1	4	1210	84,6		75	16	25	9			0,60
	91100802	2	5	1210	84,6	51		28			3	25	0,70
	91100803	3	5	1210	84,6	51		40			15	25	0,80
	91100804	4	5	1210	84,6	51		52			27	25	0,90
85	91100851	1	4	1210	89,6		75	16	25	9			0,80
	91100852	2	5	1610	89,6	60		28			3	25	0,70
	91100853	3	5	1610	89,6	60		40			15	25	0,80
	91100854	4	5	1610	89,6	60		42			27	25	1,00
	91100855	5	5	1610	89,6	60		64			39	25	1,30
90	91100901	1	4	1210	94,6		75	16	25	9			0,80
	91100902	2	5	1610	94,6	61		28			3	25	0,80
	91100903	3	5	1610	94,6	61		40			15	25	0,90
	91100904	4	5	1610	94,6	61		42			27	25	1,10
	91100905	5	5	1610	94,6	61		64			39	25	1,40
95	91100951	1	4	1210	99,6		75	16	25	9			0,90
	91100952	2	5	1610	99,6	66		28			3	25	0,80
	91100953	3	5	1610	99,6	66		40			15	25	1,10
	91100954	4	5	1610	99,6	66		52			27	25	1,30
	91100955	5	5	1610	99,6	66		64			39	25	1,50
100	91101001	1	4	1210	104,6		75	16	25	9			0,90
	91101002	2	5	1610	104,6	71		28			3	25	1,20
	91101003	3	5	1610	104,6	71		40			15	25	1,20
	91101004	4	5	1610	104,6	72		52			27	25	1,40
	91101005	5	5	2012	104,6	72		64			32	32	1,60
106	91101061	1	4	1610	110,6		80	16	25	9			1,00
	91101062	2	5	1610	110,6	76		28			3	25	1,20
	91101063	3	5	1610	110,6	78		40			15	25	1,40
	91101064	4	5	1610	110,6	80		52			27	25	1,60
	91101065	5	5	2012	110,6	78		64			32	32	1,80

MATERIAL **CAST-IRON**

CAD drawings available on our site
www.chiaravalli.com

Quantity, availability and prices
 on B2B Chiaravalli

TAPER BUSHES
SPZ TYPE

We are engaged to respect shapes and dimensions shown on this sheet but, we reserve the right to make changes and modifications without notice.

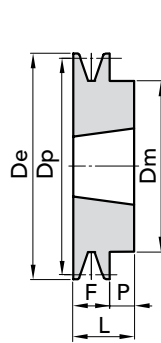
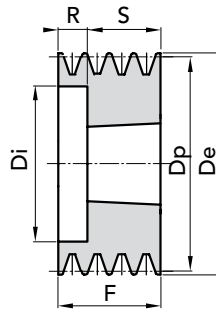
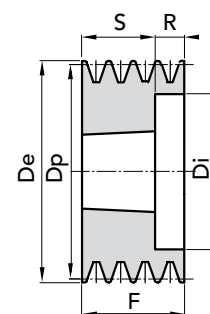
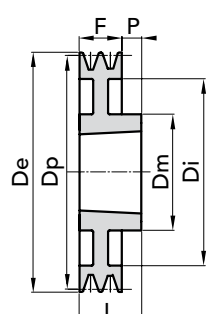
EXEC. 4

EXEC. 5

EXEC. 6

EXEC. 8

Dp	P. NUMBER	N°	EXEC.	BUSHE	Ø De	Ø Di	Ø Dm	F	L	P	R	S	WEIGHT
GROOVES													
Kg.													
112	91101121	1	4	1610	116,6		80	16	25	9			1,10
	91101122	2	5	1610	116,6	84		28			3	25	1,30
	91101123	3	5	2012	116,6	84		40			8	32	1,50
	91101124	4	5	2012	116,6	86		52			20	32	1,60
	91101125	5	5	2012	116,6	84		64			32	32	1,90
118	91101181	1	4	1610	122,6		80	16	25	9			1,30
	91101182	2	5	1610	122,6	90		28			3	25	1,40
	91101183	3	5	2012	122,6	92		40			8	32	1,60
	91101184	4	5	2012	122,6	92		52			20	32	1,90
	91101185	5	5	2012	122,6	90		64			32	32	2,40
125	91101251	1	4	1610	129,6		80	16	25	9			1,40
	91101252	2	5	1610	129,6	97		28			3	25	1,70
	91101253	3	6	2012	129,6	97		40			8	32	2,00
	91101254	4	6	2012	129,6	99		52			20	32	2,20
	91101255	5	5	2012	129,6	97		64			32	32	2,80
132	91101321	1	4	1610	136,6		80	16	25	9			1,50
	91101322	2	5	1610	136,6	104		28			3	25	2,00
	91101323	3	6	2012	136,6	104		40			8	32	2,40
	91101324	4	6	2012	136,6	104		52			20	32	2,60
	91101325	5	5	2517	136,6	104		64			19	45	2,80
140	91101401	1	4	1610	144,6		80	16	25	9			1,50
	91101402	2	5	1610	144,6	112		28			3	25	2,20
	91101403	3	6	2012	144,6	112		40			8	32	2,80
	91101404	4	6	2012	144,6	112		52			20	32	3,00
	91101405	5	6	2517	144,6	112		64			19	45	3,20
150	91101501	1	4	1610	154,6		80	16	25	9			1,60
	91101502	2	4	2012	154,6		100	28	32	4			2,30
	91101503	3	6	2012	154,6	122		40			8	32	3,40
	91101504	4	6	2517	154,6	122		52			7	45	3,60
	91101505	5	6	2517	154,6	122		64			19	45	3,90
160	91101601	1	4	1610	164,6		80	16	25	9			1,70
	91101602	2	4	2012	164,6		100	28	32	4			3,10
	91101603	3	6	2012	164,6	132		40			8	32	3,60
	91101604	4	6	2517	164,6	132		52			7	45	4,50
	91101605	5	6	2517	164,6	132		64			19	45	4,70
180	91101801	1	4	1610	184,6		80	16	25	9			2,00
	91101802	2	8	2012	184,6	152	100	28	32	4			2,90
	91101803	3	6	2012	184,6	152		40			8	32	3,70
	91101804	4	6	2517	184,6	152		52			7	45	6,30
	91101805	5	6	2517	184,6	152		64			19	45	6,80

MATERIAL CAST-IRON

CAD drawings available on our site
www.chiaravalli.com

Quantity, availability and prices
 on B2B Chiaravalli



TAPER BUSHES

SECTION **SPZ**

We are engaged to respect shapes and dimensions shown on this sheet but, we reserve the right to make changes and modifications without notice.

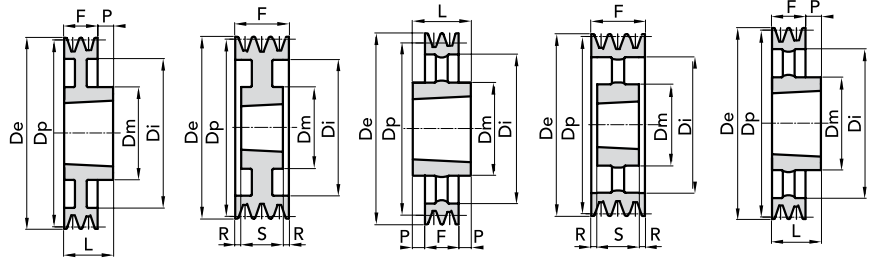

ESEC. 8

ESEC. 9

ESEC. 11

ESEC. 12

ESEC. 13

Dp	P. NUMBER	N°	EXEC.	BUSHE	Ø De	Ø Di	Ø Dm	F	L	P	R	S	WEIGHT
GROOVES													Kg.
190	91101902	2	8	2012	194,6	160	100	28	32	4			3,10
	91101903	3	9	2012	194,6	160	105	40			4	32	3,40
	91101904	4	9	2517	194,6	160	120	52			3,5	45	5,30
200	91102001	1	8	2012	204,6	172	100	16	32	16			3,40
	91102002	2	8	2012	204,6	172	100	28	32	4			3,50
	91102003	3	9	2012	204,6	172	100	40			4	32	4,30
	91102004	4	9	2517	204,6	172	120	52			3,5	45	5,40
	91102005	5	9	2517	204,6	172	120	64			9,5	45	8,80
224	91102241	1	8	2012	228,6	196	100	16	32	16			3,60
	91102242	2	8	2012	228,6	196	100	28	32	4			4,50
	91102243	3	9	2012	228,6	196	100	40			4	32	5,40
	91102244	4	9	2517	228,6	196	120	52			3,5	45	7,00
	91102245	5	9	2517	228,6	196	120	64			9,5	45	8,80
250	91102501	1	11	2012	254,6	222	100	16	32	8			4,60
	91102502	2	11	2012	254,6	222	100	28	32	2			5,40
	91102503	3	12	2012	254,6	222	100	40			4	32	6,40
	91102504	4	12	2517	254,6	222	120	52			3,5	45	8,00
	91102505	5	12	2517	254,6	222	120	64			9,5	45	9,00
280	91102801	1	11	2012	284,6	252	100	16	32	8			5,50
	91102802	2	11	2012	284,6	252	100	28	32	2			6,20
	91102803	3	11	2517	284,6	252	120	40	45	2,5			8,30
	91102804	4	12	2517	284,6	252	120	52			3,5	45	9,50
	91102805	5	12	2517	284,6	252	120	64			9,5	45	11,00
315	91103151	1	11	2012	319,6	287	100	16	32	8			6,70
	91103152	2	11	2012	319,6	287	100	28	32	2			7,20
	91103153	3	11	2517	319,6	287	120	40	45	2,5			10,10
	91103154	4	12	2517	319,6	287	120	52			3,5	45	12,10
	91103155	5	12	2517	319,6	287	120	64			9,5	45	13,30
355	91103551	1	11	2012	359,6	326	100	16	32	8			6,80
	91103552	2	11	2012	359,6	326	100	28	32	2			8,60
	91103553	3	11	2517	359,6	326	120	40	45	2,5			11,70
	91103554	4	12	2517	359,6	326	120	52			3,5	45	12,80
	91103555	5	12	2517	359,6	326	120	64			9,5	45	13,00
400	91104001	1	11	2012	404,6	371	112	16	32	8			6,90
	91104002	2	11	2517	404,6	371	125	28	45	8,5			9,90
	91104003	3	11	2517	404,6	371	125	40	45	2,5			13,30
	91104004	4	12	2517	404,6	371	125	52	45		3,5		13,60
	91104005	5	12	3020	404,6	371	158	64	51		6,5		15,60
450	91104501	1	11	2517	454,6	421	125	16	45	14,5			7,20
	91104502	2	11	2517	454,6	421	125	28	45	8,5			11,20
	91104503	3	11	2517	454,6	421	125	40	45	2,5			14,60
	91104504	4	12	3020	454,6	421	158	52	51		0,5		14,50
	91104505	5	12	3020	454,6	421	158	64	51		8,5		19,00
500	91105002	2	11	2517	504,6	471	125	28	45	8,5			10,50
	91105003	3	11	2517	504,6	471	125	40	45	2,5			15,80
	91105004	4	12	3020	504,6	471	158	52	51		0,5		17,34
	91105005	5	12	3030	504,6	471	148	64	76	6			22,60

MATERIAL **CAST-IRON**

CAD drawings available on our site
www.chiaravalli.com

Quantity, availability and prices
 on B2B Chiaravalli

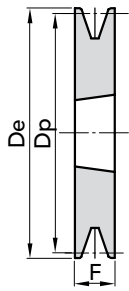

EXEC. 1

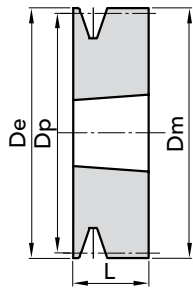

EXEC. 2

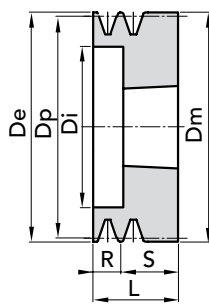

EXEC. 3

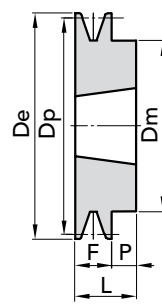

EXEC. 4

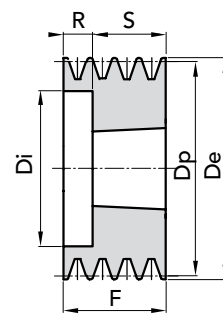

EXEC. 5

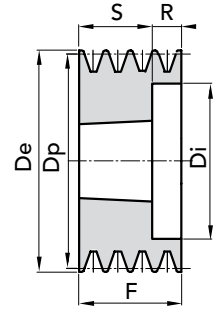

EXEC. 6

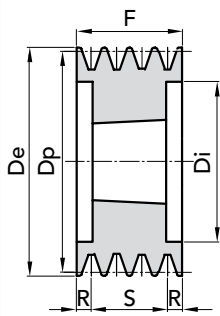

EXEC. 7

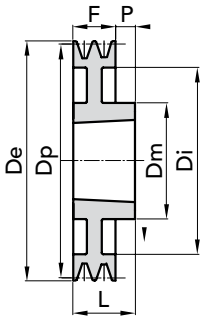

EXEC. 8

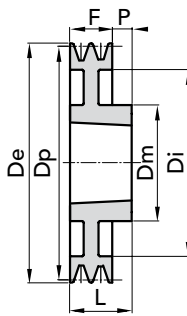

EXEC. 8A

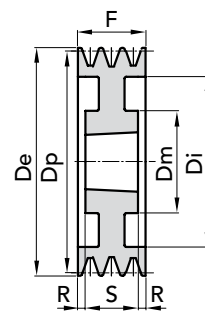

EXEC. 9

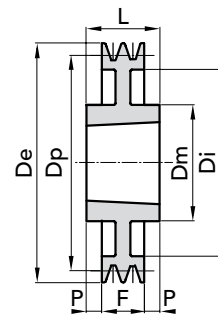

EXEC. 10

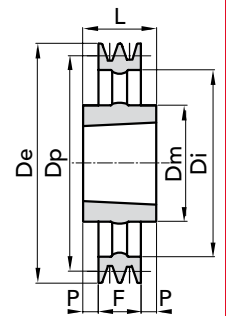

EXEC. 11

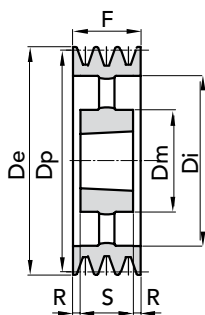

EXEC. 12

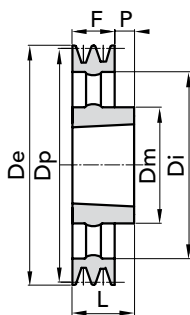

EXEC. 13

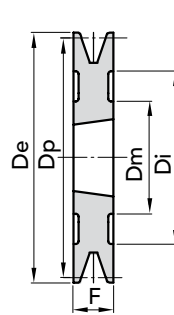

EXEC. 14

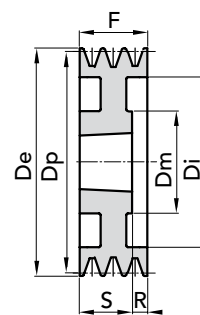

EXEC. 15

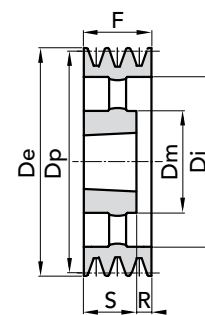

EXEC. 16

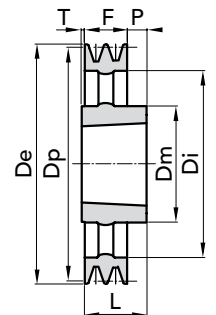

EXEC. 17



TAPER BUSHES

SPA TYPE

We are engaged to respect shapes and dimensions shown on this sheet but, we reserve the right to make changes and modifications without notice.

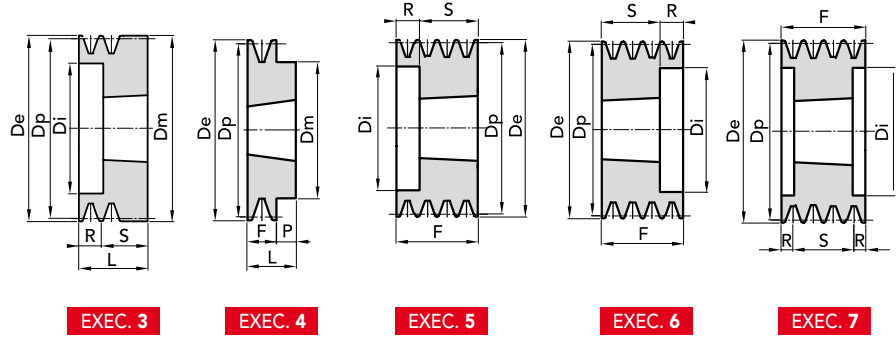

V-BELT PULLEYS for TAPER BUSHES

Dp	P. NUMBER	N°	EXEC.	BUSHE	Ø De	Ø Di	Ø Dm	F	L	P	R	S	WEIGHT
GROOVES													
Kg.													
63	91200631	1	3	1008	69,1	37	56	20	40	2	18	22	0,80
71	91200711	1	4	1108	77,1		62	20	22	2			0,50
	91200712	2	5	1108	77,1	40	62	35	22	2	13	22	0,60
	91200713	3	5	1108	77,1	40		50			28	22	0,80
75	91200751	1	4	1108	81,1		62	20	22	2			0,60
	91200752	2	5	1108	81,1	44		35			13	22	0,70
	91200753	3	5	1108	81,1	44		50			28	22	0,90
80	91200801	1	4	1210	86,1		75	20	25	5			0,70
	91200802	2	5	1210	86,1	47		35			10	25	0,70
	91200803	3	5	1210	86,1	47		50			25	25	1,10
85	91200851	1	4	1210	91,1		75	20	25	5			0,70
	91200852	2	5	1210	91,1	50		35			10	25	0,80
	91200853	3	5	1210	91,1	50		50			25	25	1,20
90	91200901	1	4	1210	96,1		75	20	25	5			0,80
	91200902	2	5	1610	96,1	60		35			10	25	0,90
	91200903	3	5	1610	96,1	60		50			25	25	1,30
95	91200951	1	4	1210	101,1		75	20	25	5			0,90
	91200952	2	5	1610	101,1	64		35			10	25	1,00
	91200953	3	5	1610	101,1	64		50			25	25	1,50
	91200954	4	7	1615	101,1	64		65			13,5	38	1,40
100	91201001	1	4	1610	106,1		80	20	25	5			1,00
	91201002	2	5	1610	106,1	70		35			10	25	1,10
	91201003	3	6	1610	106,1	70		50			25	25	1,30
	91201004	4	6	1615	106,1	70		65			27	38	1,80
	91201005	5	6	1615	106,1	70		80			42	38	2,10
106	91201061	1	4	1610	112,1		80	20	25	5			1,20
	91201062	2	5	1610	112,1	76		35			10	25	1,20
	91201063	3	6	1610	112,1	76		50			25	25	1,60
	91201064	4	5	2012	112,1	76		65			33	32	2,10
	91201065	5	5	2012	112,1	76		80			48	32	2,30
112	91201121	1	4	1610	118,1		80	20	25	5			1,30
	91201122	2	5	1610	118,1	80		35			10	25	1,40
	91201123	3	5	2012	118,1	80		50			18	32	1,60
	91201124	4	5	2012	118,1	80		65			33	32	2,00
	91201125	5	5	2012	118,1	80		80			48	32	2,50
118	91201181	1	4	1610	124,1		80	20	25	5			1,40
	91201182	2	6	1610	124,1	86		35			10	25	1,70
	91201183	3	6	2012	124,1	86		50			18	32	1,90
	91201184	4	6	2012	124,1	86		65			33	32	2,30
	91201185	5	6	2012	124,1	86		80			48	32	2,80
125	91201251	1	4	1610	131,1		80	20	25	5			1,50
	91201252	2	5	1610	131,1	90		35			10	25	1,90
	91201253	3	6	2012	131,1	92		50			18	32	2,70
	91201254	4	6	2012	131,1	92		65			33	32	3,00
	91201255	5	7	2012	131,1	92		80			24	32	3,00

MATERIAL **CAST-IRON**

CAD drawings available on our site
www.chiaravalli.com

Quantity, availability and prices
 on B2B Chiaravalli



TAPER BUSHES

SPA TYPE

We are engaged to respect shapes and dimensions shown on this sheet but, we reserve the right to make changes and modifications without notice.

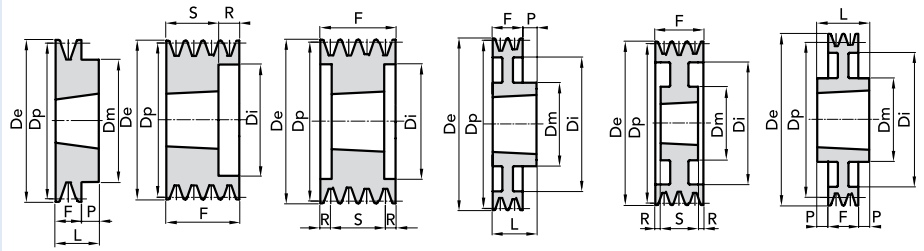

EXEC. 4

ESEC. 6

ESEC. 7

ESEC. 8

ESEC. 9

ESEC. 10

Dp	P. NUMBER	N°	EXEC.	BUSHE	Ø De	Ø Di	Ø Dm	F	L	P	R	S	WEIGHT
GROOVES													
Kg.													
132	91201321	1	4	1610	138,1		80	20	25	5			1,60
	91201322	2	5	2012	138,1	98		35			3	32	2,10
	91201323	3	6	2012	138,1	98		50			18	32	2,90
	91201324	4	6	2517	138,1	98		65			20	45	3,20
	91201325	5	7	2517	138,1	98		80			17,5	45	3,50
140	91201401	1	4	1610	146,1		80	20	25	5			1,70
	91201402	2	5	2012	146,1	106		35			3	32	2,60
	91201403	3	5	2517	146,1	106		50			5	45	3,20
	91201404	4	6	2517	146,1	106		65			20	45	3,50
	91201405	5	7	2517	146,1	106		80			17,5	45	3,90
150	91201501	1	4	1610	156,1		80	20	25	5			2,00
	91201502	2	5	2012	156,1	116		35			3	32	3,20
	91201503	3	5	2517	156,1	116		50			5	45	3,50
	91201504	4	6	2517	156,1	116		65			20	45	3,90
	91201505	5	7	2517	156,1	116		80			17,5	45	4,40
160	91201601	1	4	1610	166,1		80	20	25	5			2,40
	91201602	2	5	2012	166,1	125		35			3	32	3,60
	91201603	3	5	2517	166,1	126		50			5	45	4,50
	91201604	4	6	2517	166,1	126		65			20	45	5,10
	91201605	5	7	2517	166,1	126		80			17,5	45	5,70
170	91201701	1	4	1610	176,1		80	20	25	5			1,10
	91201702	2	5	2012	176,1	135		35			3	32	4,50
	91201703	3	5	2517	176,1	138		50			5	45	5,00
	91201704	4	6	2517	176,1	138		65			20	45	5,80
	91201705	5	7	3020	176,1	138		80			14,5	51	6,30
180	91201801	1	4	1610	186,1		80	20	25	5			2,50
	91201802	2	9	2012	186,1	148	100	35			1,5	32	5,00
	91201803	3	5	2517	186,1	146		50			5	45	6,20
	91201804	4	6	2517	186,1	146		65			20	45	6,90
	91201805	5	7	3020	186,1	146		80			14,5	51	6,90
190	91201901	1	4	1610	196,1		80	20	25	5			2,80
	91201902	2	9	2012	196,1	158	100	35			1,5	32	4,40
	91201903	3	5	2517	196,1	158		50			5	45	7,00
	91201904	4	6	2517	196,1	158		65			20	45	6,80
	91201905	5	7	3020	196,1	158		80			14,5	51	7,70
200	91202001	1	8	2012	206,1	165	100	20	32	12			2,30
	91202002	2	10	2517	206,1	165	120	35	45	5			4,90
	91202003	3	9	2517	206,1	165	120	50			2,5	45	5,80
	91202004	4	6	3020	206,1	165		65			14	51	8,40
	91202005	5	7	3020	206,1	165		80			14,5	51	9,00
212	91202121	1	8	2012	218,1	177	100	20	32	12			3,50
	91202122	2	10	2517	218,1	177	120	35	45	5			5,80
	91202123	3	9	2517	218,1	177	120	50			2,5	45	6,60
	91202124	4	6	3020	218,1	177		65			14	51	9,90
	91202125	5	7	3020	218,1	177		80			14,5	51	10,70

MATERIAL CAST-IRON

CAD drawings available on our site
www.chiaravalli.com

Quantity, availability and prices
 on B2B Chiaravalli



TAPER BUSHES

SPA TYPE

We are engaged to respect shapes and dimensions shown on this sheet but, we reserve the right to make changes and modifications without notice.

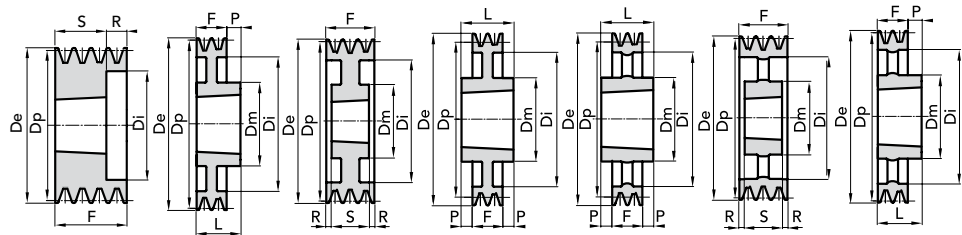

EXEC. 6

EXEC. 8

EXEC. 9

EXEC. 10

EXEC. 11

EXEC. 12

EXEC. 13

Dp	P. NUMBER	N°	EXEC.	BUSHE	Ø De	Ø Di	Ø Dm	F	L	P	R	S	WEIGHT
GROOVES													Kg.
224	91202241	1	8	2012	230,1	189	100	20	32	12			4,00
	91202242	2	8	2517	230,1	189	120	35	45	10			6,60
	91202243	3	9	2517	230,1	189	120	50			2,5	45	7,50
	91202244	4	6	3020	230,1	189		65			14	51	11,40
	91202245	5	6	3020	230,1	189		80			29	51	12,30
236	91202361	1	8	2012	242,1	202	106	20	32	12			3,60
	91202362	2	8	2517	242,1	202	125	35	45	10			5,40
	91202363	3	9	2517	242,1	202	125	50			2,5	45	6,60
	91202364	4	9	3020	242,1	202	146	65			7	51	9,80
	91202365	5	9	3020	242,1	202	155	80			14,5	51	11,20
250	91202501	1	10	2012	256,1	215	100	20	32	6			4,20
	91202502	2	10	2517	256,1	215	120	35	45	5			6,80
	91202503	3	9	2517	256,1	215	120	50			2,5	45	6,80
	91202504	4	9	3020	256,1	215	150	65			7	51	10,50
	91202505	5	9	3020	256,1	215	150	80			14,5	51	11,70
280	91202801	1	8	2012	286,1	245	100	20	32	12			6,30
	91202802	2	8	2517	286,1	245	120	35	45	10			8,30
	91202803	3	9	2517	286,1	245	120	50			2,5	45	10,00
	91202804	4	9	3020	286,1	245	150	65			7	51	11,50
	91202805	5	10	3535	286,1	245	170	80	89	4,5			17,40
300	91203001	1	8	2012	306,1	264	112	20	32	12			5,20
	91203002	2	8	2517	306,1	264	125	35	45	10			6,80
	91203003	3	10	3020	306,1	264	146	50	51	0,5			9,10
	91203004	4	9	3020	306,1	264	146	65			7	51	12,40
	91203005	5	8	3535	306,1	264	175	80	89	9			16,50
315	91203151	1	13	2012	321,1	280	100	20	32	12			7,20
	91203152	2	13	2517	321,1	280	120	35	45	10			10,20
	91203153	3	10	3020	321,1	280	150	50	51	0,5			12,80
	91203154	4	9	3020	321,1	280	150	65			7	51	13,80
	91203155	5	10	3535	321,1	280	170	80	89	4,5			20,00
335	91203353	3	11	3020	341,1	300	150	50	51	0,5			11,40
	91203354	4	12	3020	341,1	300	150	65			7	51	13,20
	91203355	5	10	3535	341,1	300	170	80	89	4,5			19,00
355	91203551	1	13	2012	361,1	320	100	20	32	12			7,70
	91203552	2	13	2517	361,1	320	120	35	45	10			10,50
	91203553	3	11	3020	361,1	320	150	50	51	0,5			13,40
	91203554	4	12	3020	361,1	320	150	65			7	51	15,80
	91203555	5	11	3535	361,1	320	170	80	89	4,5			22,80
400	91204001	1	13	2012	406,1	365	100	20	32	12			7,90
	91204002	2	13	2517	406,1	365	120	35	45	10			11,30
	91204003	3	11	3020	406,1	365	150	50	51	0,5			15,90
	91204004	4	12	3020	406,1	365	150	65			7	51	17,70
	91204005	5	11	3535	406,1	365	170	80	89	4,5			24,80

MATERIAL CAST-IRON

CAD drawings available on our site
www.chiaravalli.com

Quantity, availability and prices
 on B2B Chiaravalli



TAPER BUSHES

SPA TYPE

We are engaged to respect shapes and dimensions shown on this sheet but, we reserve the right to make changes and modifications without notice.

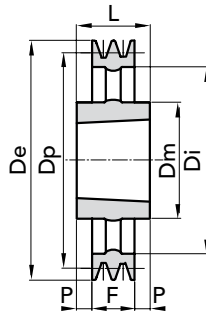

EXEC. 11

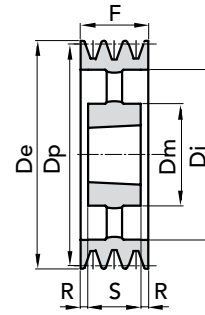

EXEC. 12

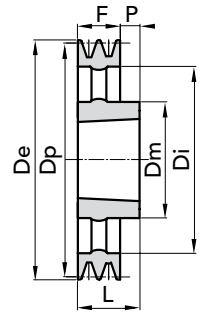

EXEC. 13

Dp	P. NUMBER	N°	EXEC.	BUSHE	Ø De	Ø Di	Ø Dm	F	L	P	R	S	WEIGHT Kg.
GROOVES													
450	91204501	1	13	2012	456,1	415	100	20	32	12			8,30
	91204502	2	13	2517	456,1	415	120	35	45	10			15,00
	91204503	3	11	3020	456,1	415	150	50	51	0,5			19,30
	91204504	4	12	3020	456,1	415	150	65			7	51	23,20
	91204505	5	11	3535	456,1	415	170	80	89	4,5			28,50
500	91205001	1	13	2517	506,1	465	120	20	45	25			9,40
	91205002	2	13	2517	506,1	465	120	35	45	10			18,70
	91205003	3	11	3020	506,1	465	150	50	51	0,5			22,60
	91205004	4	12	3020	506,1	465	150	65			7	51	27,40
	91205005	5	11	3535	506,1	465	170	80	89	4,5			31,70
560	91205603	3	13	3020	566,1	525	150	50	51	0,5			23,50
	91205604	4	11	3535	566,1	525	170	65	89	12			30,50
	91205605	5	11	3535	566,1	525	170	80	89	4,5			35,00
630	91206302	2	13	3020	636,1	595	150	35	51	16			22,00
	91206303	3	11	3020	636,1	595	150	50	51	0,5			27,50
	91206304	4	11	3535	636,1	595	170	65	89	12			34,10
	91206305	5	11	3535	636,1	595	170	80	89	4,5			42,00
	91206306	6	11	4040	636,1	595	200	95	102	3,5			53,50
	800	91208003	3	11	3535	806,1	765	170	50	89	19,5		
91208004		4	11	3535	806,1	765	170	65	89	12			50,80
91208005		5	11	4040	806,1	765	200	80	102	11			60,00

MATERIAL **CAST-IRON**

CAD drawings available on our site
www.chiaravalli.com

Quantity, availability and prices
 on B2B Chiaravalli



TAPER BUSHES

SPB TYPE

We are engaged to respect shapes and dimensions shown on this sheet but, we reserve the right to make changes and modifications without notice.

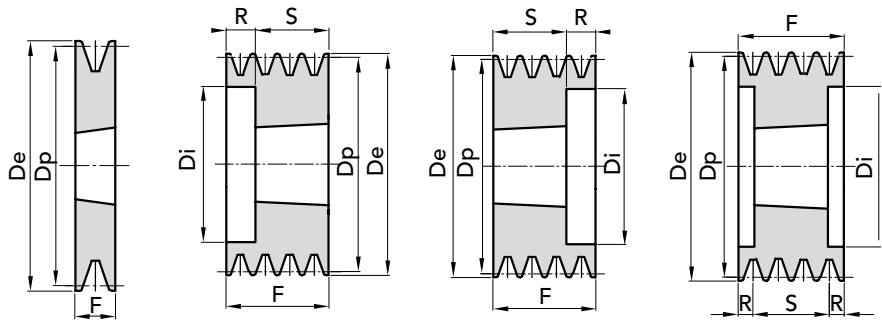

EXEC. 1

EXEC. 5

EXEC. 6

EXEC. 7

Dp	P. NUMBER	N°	EXEC.	BUSHE	Ø De	Ø Di	Ø Dm	F	L	P	R	S	WEIGHT
GROOVES													Kg.
100	91301001	1	1	1610	107,6			25					0,90
	91301002	2	6	1610	107,6	57		44			19	25	1,40
106	91301061	1	1	1610	113,6			25					1,00
	91301062	2	6	1610	113,6	67		44			19	25	1,60
	91301063	3	6	1610	113,6	67		63			38	25	2,20
112	91301121	1	1	1610	119,6			25					1,20
	91301122	2	5	1610	119,6	72		44			19	25	1,70
	91301123	3	6	1610	119,6	72		63			38	25	2,40
118	91301181	1	1	1610	125,6			25					1,30
	91301182	2	6	1610	125,6	78		44			19	25	1,80
	91301183	3	6	1610	125,6	78		63			38	25	2,60
125	91301251	1	1	1610	132,6			25					1,50
	91301252	2	6	2012	132,6	82		44			12	32	1,90
	91301253	3	6	2012	132,6	82		63			31	32	2,50
	91301254	4	7	2012	132,6	82		82			25	32	3,00
	91301255	5	5/6	2012	132,6	82		101			69	32	3,60
132	91301321	1	1	1610	139,6			25					1,70
	91301322	2	6	2012	139,6	89		44			12	32	2,50
	91301323	3	6	2012	139,6	89		63			31	32	3,20
	91301324	4	7	2012	139,6	89		82			25	32	3,70
	91301325	5	5	2517	139,6	89		101			56	45	3,80
140	91301401	1	1	1610	147,6			25					1,80
	91301402	2	6	2012	147,6	97		44			12	32	2,70
	91301403	3	6	2012	147,6	97		63			31	32	3,60
	91301404	4	7	2517	147,6	97		82			18,5	45	4,30
	91301405	5	7	2517	147,6	97		101			28	45	4,40
	91301406	6	7	2517	147,6	97		120			37,5	45	4,70
	91301408	8	7	2517	147,6	97		158			56,5	45	7,00
	150	91301501	1	1	1610	157,6			25				
91301502		2	6	2012	157,6	107		44			12	32	3,20
91301503		3	6	2517	157,6	107		63			18	45	4,00
91301504		4	7	2517	157,6	107		82			18,5	45	4,60
91301505		5	7	2517	157,6	107		101			28	45	5,40
91301506		6	7	2517	157,6	107		120			37,5	45	6,80
160	91301601	1	1	1610	167,6			25					2,50
	91301602	2	6	2012	167,6	117		44			12	32	3,80
	91301603	3	6	2517	167,6	117		63			18	45	4,50
	91301604	4	7	2517	167,6	117		82			18,5	45	5,80
	91301605	5	7	2517	167,6	117		101			28	45	6,70
	91301606	6	7	3020	167,6	117		120			34,5	51	7,20
	91301608	8	7	3020	167,6	117		158			53,5	51	8,30

V-BELT PULLEYS for TAPER BUSHES

MATERIAL **CAST-IRON**

CAD drawings available on our site
www.chiaravalli.com

Quantity, availability and prices
 on B2B Chiaravalli



TAPER BUSHES

SPB TYPE

We are engaged to respect shapes and dimensions shown on this sheet but, we reserve the right to make changes and modifications without notice.

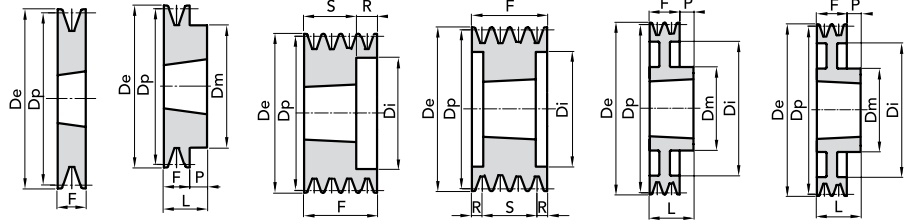

EXEC. 1

EXEC. 4

EXEC. 6

EXEC. 7

EXEC. 8

EXEC. 8A

Dp	P. NUMBER	N°	EXEC.	BUSHE	Ø De	Ø Di	Ø Dm	F	L	P	R	S	WEIGHT
GROOVES													
Kg.													
170	91301701	1	1	1610	177,6			25					2,90
	91301702	2	6	2012	177,6	127		44			12	32	4,80
	91301703	3	6	2517	177,6	127		63			18	45	5,30
	91301704	4	7	2517	177,6	127		82			18,5	45	6,70
	91301705	5	7	3020	177,6	127		101			25	51	7,10
	91301706	6	7	3020	177,6	127		120			34,5	51	7,60
180	91301801	1	14	1610	187,6	137	80	25					3,80
	91301802	2	4	2517	187,6		120	44	45	1			5,50
	91301803	3	6	2517	187,6	137		63			18	45	6,70
	91301804	4	7	2517	187,6	137		82			18,5	45	7,70
	91301805	5	7	3020	187,6	137		101			25	51	8,20
	91301806	6	7	3020	187,6	137		120			34,5	51	10,20
	91301808	8	7	3030	187,6	137		158			41	76	10,80
	190	91301901	1	10	2012	197,6	147	100	25	32	3,5		
91301902		2	4	2517	197,6		120	44	45	1			6,50
91301903		3	6	2517	197,6	147		63			18	45	7,60
91301904		4	7	2517	197,6	147		82			18,5	45	8,60
91301905		5	7	3020	197,6	147		101			25	51	9,10
91301906		6	7	3020	197,6	147		120			34,5	51	10,20
91301908		8	7	3030	197,6	147		158			41	76	12,30
200		91302001	1	10	2012	207,6	157	100	25	32	3,5		
	91302002	2	4	2517	207,6	157	120	44	45	1			7,50
	91302003	3	6	2517	207,6	157		63			18	45	8,90
	91302004	4	6/7	3020	207,6	157		82			18,5	45	9,10
	91302005	5	7	3020	207,6	157		101			25	51	10,30
	91302006	6	7	3020	207,6	157		120			34,5	51	11,70
	91302008	8	7	3535	207,6	161		158			34,5	89	13,70
	212	91302121	1	10	2012	219,6	169	100	25	32	3,5		
91302122		2	8	2517	219,6	169	120	44	45	1			7,00
91302123		3	15	2517	219,6	169	120	63			18	45	8,20
91302124		4	7	3020	219,6	169		82			15,5	51	10,90
91302125		5	7	3020	219,6	169		101			25	51	12,20
91302126		6	7	3535	219,6	169		120			15,5	89	13,20
91302128		8	7	3535	219,6	173		158			34,5	89	15,80
224		91302241	1	10	2012	231,6	181	100	25	32	3,5		
	91302242	2	8a	2517	231,6	181	120	44	45	1			7,70
	91302243	3	15	2517	231,6	181	120	63			18	45	9,10
	91302244	4	6/7	3020	231,6	181		82			15,5	51	12,40
	91302245	5	7	3020	231,6	181		101			25	51	13,70
	91302246	6	7	3535	231,6	181		120			15,5	89	15,20
	91302248	8	7	3535	231,6	181		158			34,5	89	17,20
	91302210	10	7	3535	231,6	181		196			53,5	89	20,50

MATERIAL **CAST-IRON**

CAD drawings available on our site
www.chiaravalli.com

EXEC. 10

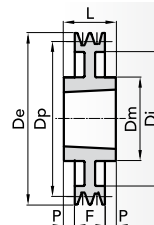

EXEC. 14

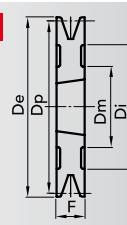

EXEC. 15

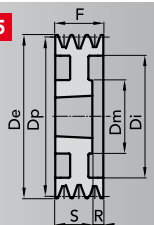



TAPER BUSHES

SPB TYPE

We are engaged to respect shapes and dimensions shown on this sheet but, we reserve the right to make changes and modifications without notice.

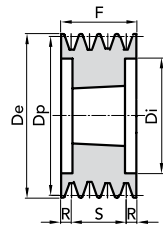

EXEC. 7

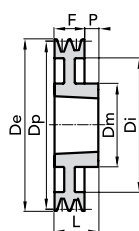

EXEC. 8A

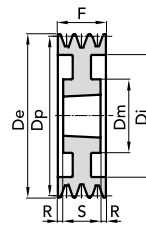

EXEC. 9

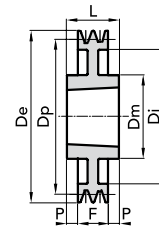

EXEC. 10

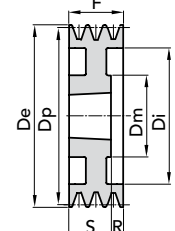

EXEC. 15

Dp	P. NUMBER	N°	EXEC.	BUSHE	Ø De	Ø Di	Ø Dm	F	L	P	R	S	WEIGHT
GROOVES													Kg.
236	91302361	1	10	2012	243,6	193	100	25	32	3,5			5,40
	91302362	2	8a	2517	243,6	193	120	44	45	1			8,30
	91302363	3	15	2517	243,6	193	120	63			18	45	9,80
	91302364	4	7	3020	243,6	193		82			15,5	51	14,10
	91302365	5	7	3535	243,6	193		101			6	89	16,20
	91302366	6	7	3535	243,6	193		120			15,5	89	17,60
	91302368	8	7	3535	243,6	193		158			34,5	89	20,00
250	91302501	1	10	2012	257,6	207	100	25	32	3,5			6,200
	91302502	2	8a	2517	257,6	207	120	44	45	1			8,600
	91302503	3	15	3020	257,6	207	150	63			12	51	11,20
	91302504	4	9	3020	257,6	207	150	82			15,5	51	12,70
	91302505	5	7	3535	257,6	207		101			6	89	18,60
	91302506	6	7	3535	257,6	207		120			15,5	89	20,20
	91302508	8	7	3535	257,6	207		158			34,5	89	23,20
280	91302801	1	10	2012	287,6	237	100	25	32	3,5			6,50
	91302802	2	8a	2517	287,6	237	120	44	45	1			10,10
	91302803	3	9	3020	287,6	237	150	63			6	51	12,00
	91302804	4	9	3020	287,6	237	150	82			15,5	51	14,10
	91302805	5	9	3535	287,6	237	170	101			6	89	21,40
	91302806	6	9	3535	287,6	237	170	120			15,5	89	23,50
	91302808	8	9	3535	287,6	237	175	158			34,5	89	26,60
300	91303001	1	10	2012	307,6	257	100	25	32	3,5			7,00
	91303002	2	8a	2517	307,6	257	120	44	45	1			11,00
	91303003	3	9	3020	307,6	257	150	63			6	51	13,50
	91303004	4	9	3020	307,6	257	150	82			15,5	51	20,50
	91303005	5	9	3535	307,6	257	170	101			6	89	22,50
	91303006	6	9	3535	307,6	257	170	120			15,5	89	24,00
	91303008	8	9	3535	307,6	257	175	158			34,5	89	27,30
315	91303151	1	10	2012	322,6	272	100	25	32	3,5			7,50
	91303152	2	8a	2517	322,6	272	120	44	45	1			12,20
	91303153	3	9	3020	322,6	272	150	63			6	51	14,20
	91303154	4	10	3535	322,6	272	170	82	89	3,5			20,60
	91303155	5	9	3535	322,6	272	170	101			6	89	22,30
	91303156	6	9	3535	322,6	272	170	120			15,5	89	24,20
	91303158	8	9	3535	322,6	272	175	158			34,5	89	28,00
335	91303352	2	8a	2517	342,6	292	120	44	45	1			14,00
	91303353	3	9	3020	342,6	292	150	63			6	51	16,00
	91303354	4	10	3535	342,6	292	170	82	89	3,5			22,00
	91303355	5	9	3535	342,6	292	170	101			6	89	24,00
	91303356	6	9	3535	342,6	292	170	120			15,5	89	26,30
	91303358	8	9	3535	342,6	292	175	158			34,5	89	30,50

MATERIAL CAST-IRON

CAD drawings available on our site
www.chiaravalli.com

Quantity, availability and prices
 on B2B Chiaravalli



TAPER BUSHES

SPB TYPE

We are engaged to respect shapes and dimensions shown on this sheet but, we reserve the right to make changes and modifications without notice.

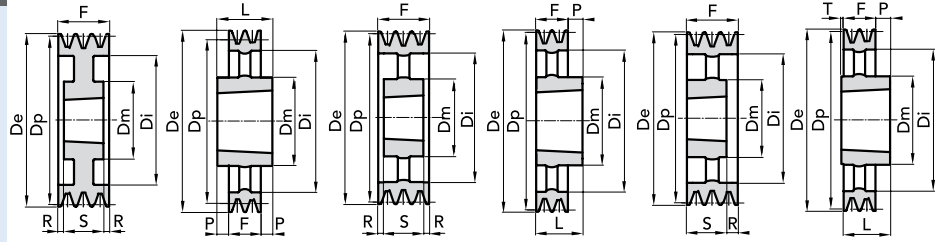

EXEC. 9

EXEC. 11

EXEC. 12

EXEC. 13

EXEC. 16

EXEC. 17

Dp	P. NUMBER	N°	EXEC.	BUSHE	Ø De	Ø Di	Ø Dm	F	L	P	R	S	T	WEIGHT	
GROOVES														Kg.	
355	91303552	2	11	3020	362,6	312	150	44	51	3,5				15,90	
	91303553	3	12	3020	362,6	312	150	63			6	51		17,70	
	91303554	4	10	3535	362,6	312	170	82	89	3,5				23,20	
	91303555	5	12	3535	362,6	312	170	101			6	89		25,50	
	91303556	6	9	3535	362,6	312	170	120			15,5	89		28,40	
	91303558	8	9	3535	362,6	312	170	158			35,5	89		31,50	
	91303510	10	9	4030	362,6	312	210	196				60	76		33,50
375	91303754	4	10	3535	382,6	332	170	82	89	3,5				27,00	
400	91304002	2	11	3020	407,6	357	150	44	51	3,5				18,30	
	91304003	3	11	3535	407,6	357	170	63	89	13				25,00	
	91304004	4	11	3535	407,6	357	170	82	89	3,5				26,50	
	91304005	5	12	3535	407,6	357	170	101			6	89		30,20	
	91304006	6	12	3535	407,6	357	170	120			15,5	89		31,80	
	91304008	8	9	4040	407,6	357	200	158				28	102		43,00
450	91304502	2	11	3020	457,6	407	150	44	51	3,5				19,00	
	91304503	3	13	3535	457,6	407	170	63	89	26				26,30	
	91304504	4	13	3535	457,6	407	170	82	89	7				27,20	
	91304505	5	16	3535	457,6	407	170	101			12	89		32,80	
	91304506	6	16	4040	457,6	407	200	120			18	102		35,30	
	91304508	8	12	4040	457,6	407	200	158			28	102		46,00	
500	91305002	2	11	3020	507,6	457	150	44	51	3,5				21,00	
	91305003	3	13	3535	507,6	457	170	63	89	26				29,90	
	91305004	4	13	3535	507,6	457	170	82	89	7				34,70	
	91305005	5	16	3535	507,6	457	170	101			12	89		36,70	
	91305006	6	16	4040	507,6	457	200	120			18	102		40,70	
	91305008	8	12	4040	507,6	457	200	158			28	102		52,00	
	560	91305602	2	17	3030	567,6	517	150	44	76	28			4	24,00
		91305603	3	13	3535	567,6	517	170	63	89	26				37,20
91305604		4	13	3535	567,6	517	170	82	89	7				39,00	
91305605		5	13	4040	567,6	517	200	101	102	1				45,60	
91305606		6	16	4040	567,6	517	200	120			18	102		49,20	
91305608		8	12	4545	567,6	517	225	158			22	114		54,50	
630	91306303	3	13	3535	637,6	587	170	63	89	26				41,00	
	91306304	4	13	3535	637,6	587	170	82	89	7				44,50	
	91306305	5	13	4040	637,6	587	200	101	102	1				50,00	
	91306306	6	16	4040	637,6	587	200	120			18	102		53,50	
	91306308	8	12	4545	637,6	587	225	158			22	114		67,00	
	710	91307103	3	17	3535	717,6	664	170	63	89	22			4	48,00
91307104		4	11	3535	717,6	664	170	82	89	3,5				50,50	
91307105		5	11	4040	717,6	664	200	101	102	0,5				63,50	
91307106		6	12	4545	717,6	664	225	120			3	114		69,00	
91307108		8	12	4545	717,6	664	225	158			22	114		75,50	
91307010		10	12	4545	717,6	664	225	196				41	114		82,00

MATERIAL CAST-IRON

CAD drawings available on our site
www.chiaravalli.com

Quantity, availability and prices
 on B2B Chiaravalli



TAPER BUSHES

SPB TYPE

We are engaged to respect shapes and dimensions shown on this sheet but, we reserve the right to make changes and modifications without notice.

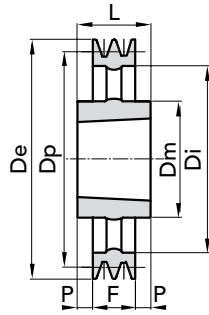

EXEC. 11

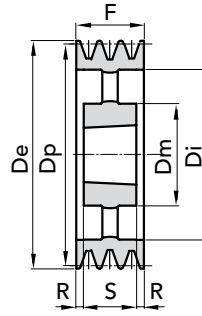

EXEC. 12

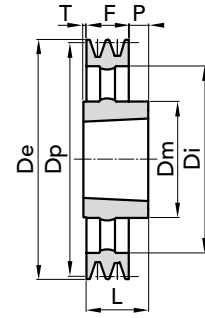

EXEC. 17

Dp	P. NUMBER	N°	EXEC.	BUSHE	Ø De	Ø Di	Ø Dm	F	L	P	R	S	T	WEIGHT
GROOVES														Kg.
800	91308003	3	17	3535	807,6	754	170	63	89	22			4	55,00
	91308004	4	17	4040	807,6	754	200	82	102	16			4	60,50
	91308005	5	11	4040	807,6	754	200	101	102	5				67,00
	91308006	6	12	4545	807,6	754	225	120			3	114		84,50
	91308008	8	12	4545	807,6	754	225	158			22	114		94,50
	91308010	10	12	4545	807,6	754	225	196				41	114	
900	91309003	3	17	3535	907,6	854	170	63	89	22			4	64,10
	91309004	4	17	4040	907,6	854	200	82	102	16			4	70,00
1000	91310003	3	17	4040	1007,6	954	200	63	102	33			6	72,00
	91310004	4	17	4040	1007,6	954	200	82	102	16			4	77,50
	91310005	5	11	4545	1007,6	954	225	101	114	6,5				110,0
	91310006	6	12	4545	1007,6	954	225	120			2	114		114,0
	91310008	8	12	5050	1007,6	954	245	158			15,5	127		121,5
	91310010	10	12	5050	1007,6	954	245	196				34,5	127	
1250	91312503	3	17	4040	1257,6	1204	200	63	102	33			6	140,0
	91312504	4	17	4545	1257,6	1204	225	82	114	26			6	162,0
	91312505	5	11	4545	1257,6	1204	225	101	114	6,5				180,0
	91312506	6	11	5050	1257,6	1204	245	120	127	3,5				210,0
	91312508	8	12	5050	1257,6	1204	245	158			15,5	127		242,0
	91312510	10	12	5050	1257,6	1204	245	196				34,5	127	

V-BELT PULLEYS for TAPER BUSHES

MATERIAL **CAST-IRON**

CAD drawings available on our site
www.chiaravalli.com

Quantity, availability and prices
 on B2B Chiaravalli



TAPER BUSHES

SPC TYPE

We are engaged to respect shapes and dimensions shown on this sheet but, we reserve the right to make changes and modifications without notice.

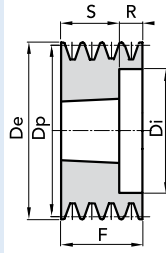

EXEC. 6

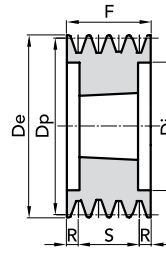

EXEC. 7

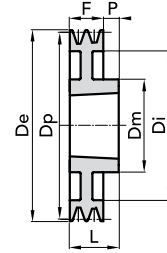

EXEC. 8

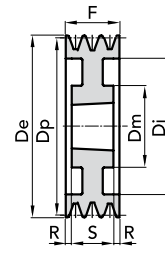

EXEC. 9

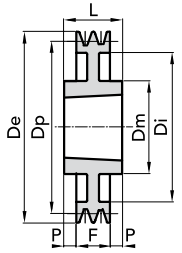

EXEC. 10

Dp	P. NUMBER	N°	EXEC.	BUSHE	Ø De	Ø Di	Ø Dm	F	L	P	R	S	WEIGHT Kg.	
GROOVES														
180	91401803	3	7	2517	190,2	128		85			20	45	9,20	
	91401804	4	7	2517	190,2	124		110,5			32,75	45	11,50	
	91401805	5	7	3020	190,2	124		136			42,5	51	13,70	
	91401806	6	7	3020	190,2	124		161,5			55,25	51	16,50	
200	91402002	2	6	2517	210,2	144		59,5			14,5	45	10,00	
	91402003	3	7	2517	210,2	144		85			17	51	10,20	
	91402004	4	7	3020	210,2	144		110,5			10,75	89	11,30	
	91402005	5	7	3535	210,2	144		136			23,5	89	12,20	
	91402006	6	7	3535	210,2	144		161,5			36,25	89	14,10	
	91402008	8	7	3535	210,2	144		212,5			61,75	89	20,00	
	224	91402242	2	6	3020	234,2	173		59,5			8,5	51	11,00
		91402243	3	7	3020	234,2	173		85			17	51	12,70
91402244		4	7	3535	234,2	173		110,5			10,75	89	14,50	
91402245		5	7	3535	234,2	173		136			23,5	89	16,60	
91402246		6	7	3535	234,2	173		161,5			36,25	89	18,00	
91402248		8	7	3535	234,2	170		212,5			61,75	89	22,90	
91402210		10	7	4040	234,2	170		263,5			80,75	102	28,00	
236		91402366	6	7	3535	246,2	180		161,5			36,25	89	21,30
250	91402502	2	6	3020	260,2	198		59,5			8,5	51	15,00	
	91402503	3	7	3020	260,2	198		85			17	51	16,50	
	91402504	4	7	3535	260,2	198		110,5			10,75	89	19,30	
	91402505	5	7	3535	260,2	198		136			23,5	89	21,50	
	91402506	6	7	3535	260,2	198		161,5			36,25	89	20,90	
	91402508	8	7	3535	260,2	198		212,5			61,75	89	29,00	
	91402510	10	7	4040	260,2	198		263,5			80,75	102	35,00	
	280	91402802	2	8	3535	290,2	228	170	59,5	89	29,5			18,00
91402803		3	8	3535	290,2	228	170	85	89	4			22,70	
91402804		4	7	3535	290,2	228		110,5			10,75	89	25,40	
91402805		5	7	3535	290,2	228		136			23,5	89	28,40	
91402806		6	7	3535	290,2	228		161,5			36,25	89	31,50	
91402808		8	7	3535	290,2	228		212,5			61,75	89	36,10	
91402810		10	7	4040	290,2	222		263,5			80,75	102	42,10	
300		91403002	2	8	3535	310,2	247	170	59,5	89	29,5			21,00
	91403003	3	10	3535	310,2	247	170	85	89	2			22,60	
	91403004	4	9	3535	310,2	247	170	110,5			10,75	89	25,00	
	91403005	5	9	3535	310,2	247	170	136			23,5	89	28,50	
	91403006	6	9	3535	310,2	247		161,5			36,25	89	31,50	
	91403008	8	7	4040	310,2	247		212,5			55,25	102	37,10	
	91403010	10	7	4545	310,2	242		263,5			74,75	114	44,10	
	315	91403152	2	8	3535	325,2	264	170	59,5	89	29,5			21,00
91403153		3	10	3535	325,2	264	170	85	89	2			22,00	
91403154		4	9	3535	325,2	264	170	110,5			10,75	89	25,30	
91403155		5	9	3535	325,2	264	170	136			23,5	89	28,10	
91403156		6	9	3535	325,2	264	170	161,5			36,25	89	33,20	
91403158		8	7	4040	325,2	258		212,5			55,25	102	40,00	
91403110		10	7	4545	325,2	258		263,5			74,75	114	47,00	

MATERIAL **CAST-IRON**

CAD drawings available on our site
www.chiaravalli.com

Quantity, availability and prices
 on B2B Chiaravalli



TAPER BUSHES

SPC TYPE

We are engaged to respect shapes and dimensions shown on this sheet but, we reserve the right to make changes and modifications without notice.

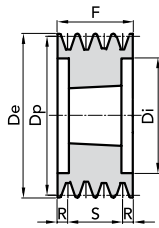

EXEC. 7

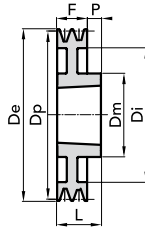

EXEC. 8

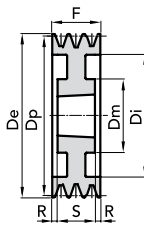

EXEC. 9

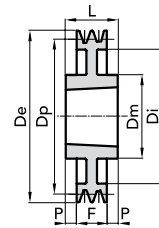

EXEC. 10

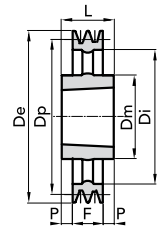

EXEC. 11

V-BELT PULLEYS for TAPER BUSHES

Dp	P. NUMBER	N°	EXEC.	BUSHE	Ø De	Ø Di	Ø Dm	F	L	P	R	S	T	WEIGHT
GROOVES														Kg.
335	91403352	2	8	3535	345,2	279	170	59,5	89	29,5				22,00
	91403353	3	10	3535	345,2	279	170	85	89	2			24,10	
	91403354	4	9	3535	345,2	279	170	110,5			10,75	89	27,50	
	91403355	5	9	3535	345,2	279	170	136			23,5	89	31,00	
	91403356	6	9	3535	345,2	279	170	161,5			36,25	89	37,50	
	91403358	8	9	4040	345,2	279	200	212,5			55,25	102	44,00	
	91403310	10	7	4545	345,2	279		263,5			74,75	114	51,00	
355	91403552	2	8	3535	365,2	304	170	59,5	89	29,5			23,00	
	91403553	3	10	3535	365,2	304	170	85	89	2			26,20	
	91403554	4	9	3535	365,2	304	170	110,5			10,75	89	29,30	
	91403555	5	9	3535	365,2	304	170	136			23,5	89	33,50	
	91403556	6	9	3535	365,2	304	170	161,5			36,25	89	40,50	
	91403558	8	7	4040	365,2	304		212,5			55,25	102	49,00	
	91403510	10	7	4545	365,2	299		263,5			74,75	114	57,00	
400	91404002	2	17	3535	410,2	344	170	59,5	89	27,5			2	17,00
	91404003	3	11	3535	410,2	344	170	85	89	2			29,30	
	91404004	4	12	3535	410,2	344	170	110,5			10,75	89	33,80	
	91404005	5	12	3535	410,2	344	170	136			23,5	89	38,50	
	91404006	6	9	4040	410,2	344	200	161,5			29,75	102	48,00	
	91404008	8	9	4545	410,2	344	225	212,5			49,75	114	58,00	
	91404010	10	7	5050	410,2	342		263,5			68,25	127	66,00	
450	91404502	2	17	3535	460,2	394	170	59,5	89	27,5			2	27,00
	91404503	3	11	3535	460,2	394	170	85	89	2			34,70	
	91404504	4	12	3535	460,2	394	170	110,5			10,75	89	41,30	
	91404505	5	12	4040	460,2	394	200	136			17	102	45,30	
	91404506	6	9	4545	460,2	394	225	161,5			23,75	114	57,50	
	91404508	8	9	5050	460,2	394	245	212,5			42,75	127	70,00	
	91404510	10	9	5050	460,2	394	245	263,5			68,25	127	78,00	
500	91405003	3	11	3535	510,2	444	170	85	89	2			40,00	
	91405004	4	12	3535	510,2	444	170	110,5			10,75	89	46,00	
	91405005	5	12	4040	510,2	444	200	136			17	102	51,00	
	91405006	6	12	4545	510,2	444	225	161,5			23,75	114	67,00	
	91405008	8	9	5050	510,2	444	245	212,5			42,75	127	82,50	
	91405010	10	9	5050	510,2	444	245	263,5			68,25	127	95,50	
	560	91405603	3	11	3535	570,2	504	170	85	89	2			45,90
91405604		4	12	4040	570,2	504	200	110,5			4,25	102	58,00	
91405605		5	12	4545	570,2	504	225	136			11	114	56,70	
91405606		6	12	5050	570,2	504	245	161,5			17,25	127	77,50	
91405608		8	12	5050	570,2	504	245	212,5			42,75	127	94,50	
91405610		10	9	5050	570,2	504	245	263,5			68,25	127	94,70	

MATERIAL CAST-IRON

EXEC. 12

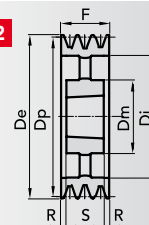

EXEC. 17

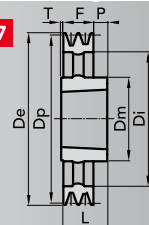

CAD drawings available on our site
www.chiaravalli.com

Quantity, availability and prices
 on B2B Chiaravalli



TAPER BUSHES

SPC TYPE

We are engaged to respect shapes and dimensions shown on this sheet but, we reserve the right to make changes and modifications without notice.

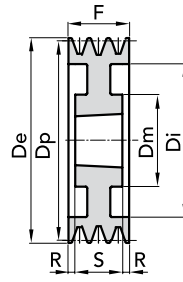

EXEC. 9

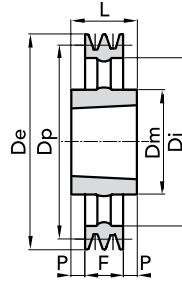

EXEC. 11

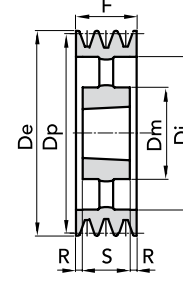

EXEC. 12

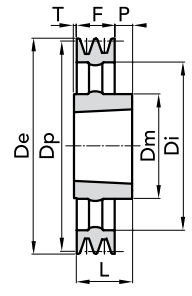

EXEC. 17

Dp	P. NUMBER	N°	EXEC.	BUSHE	Ø De	Ø Di	Ø Dm	F	L	P	R	S	T	WEIGHT
GROOVES														
Kg.														
630	91406303	3	11	4040	640,2	574	200	85	102					76,30
	91406304	4	11	4545	640,2	574	225	110,5	114	1,75				63,80
	91406305	5	12	5050	640,2	574	245	136			4,5	127		73,00
	91406306	6	12	5050	640,2	574	245	161,5			17,25	127		88,50
	91406308	8	12	5050	640,2	574	245	212,5			42,75	127		102,0
	91406310	10	9	5050	640,2	574	245	263,5			68,25	127		113,2
710	91407104	4	17	5050	720,2	654	267	110,5	127	12			4,5	83,20
	91407105	5	12	5050	720,2	654	245	136						93,00
	91407106	6	12	5050	720,2	654	245	161,5						107,3
	91407108	8	12	5050	720,2	654	245	212,5						123,5
	91407110	10	12	5050	720,2	654	245	263,5						133,4
800	91408003	3	17	5050	810,2	737	245	85	127	38			4	87,00
	91408004	4	17	5050	810,2	737	245	110,5	127	12			4,5	102,5
	91408005	5	12	5050	810,2	737	245	136			4,5	127		119,0
	91408006	6	12	5050	810,2	737	245	161,5			17,5	127		126,0
	91408008	8	12	5050	810,2	737	245	212,5			42,75	127		145,0
	91408010	10	12	5050	810,2	737	245	263,5			68,25	127		160,0
1000	91410003	3	17	5050	1010,2	937	245	85	127	38			4	120,0
	91410004	4	17	5050	1010,2	937	245	110,5	127	12			4,5	130,0
	91410005	5	12	5050	1010,2	937	245	136			4,5	127		147,0
	91410006	6	12	5050	1010,2	937	245	161,5			17,5	127		185,0
	91410008	8	12	5050	1010,2	937	245	212,5			42,75	127		207,0
	91410010	10	12	5050	1010,2	937	245	263,5			68,25	127		227,0
1250	91412503	3	17	5050	1260,2	1187	245	85	127	38			4	175,0
	91412504	4	17	5050	1260,2	1187	245	110,5	127	12			4,5	186,0
	91412505	5	12	5050	1260,2	1187	245	136			4,5	127		210,0
	91412506	6	12	5050	1260,2	1187	245	161,5			17,5	127		258,0
	91412508	8	12	5050	1260,2	1187	245	212,5			42,75	127		285,0
	91412510	10	12	5050	1260,2	1187	245	263,5			68,25	127		300,0

MATERIAL CAST-IRON

CAD drawings available on our site
www.chiaravalli.com

Quantity, availability and prices
 on B2B Chiaravalli



CAST- IRON V-BELT PULLEYS



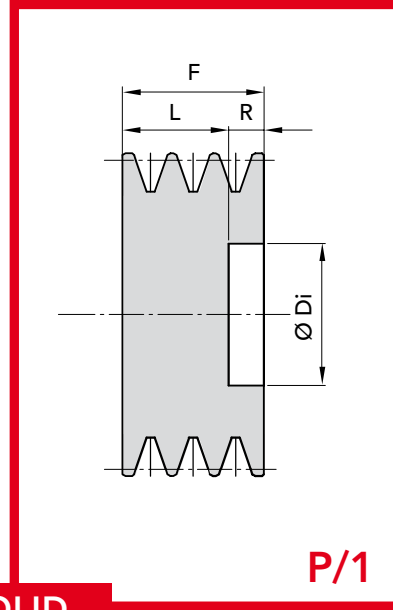
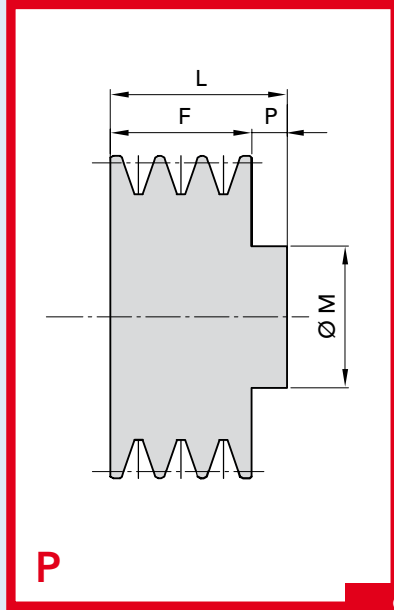

SOLID

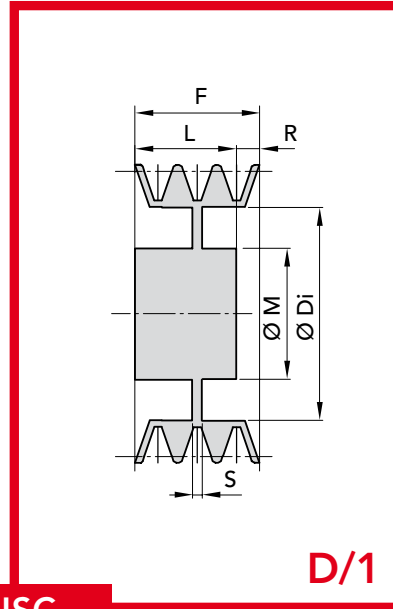
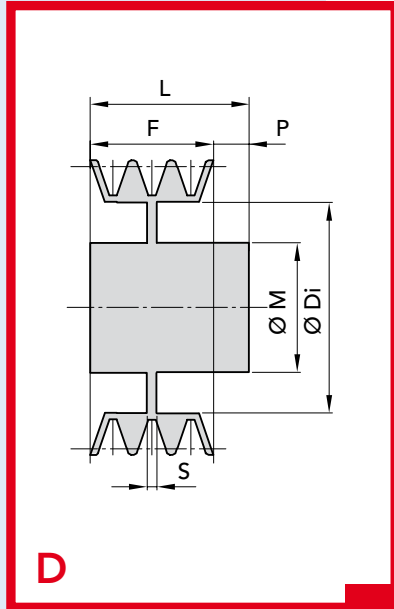

DISC

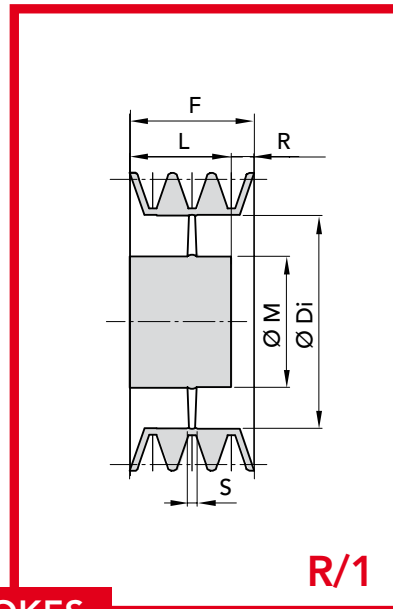
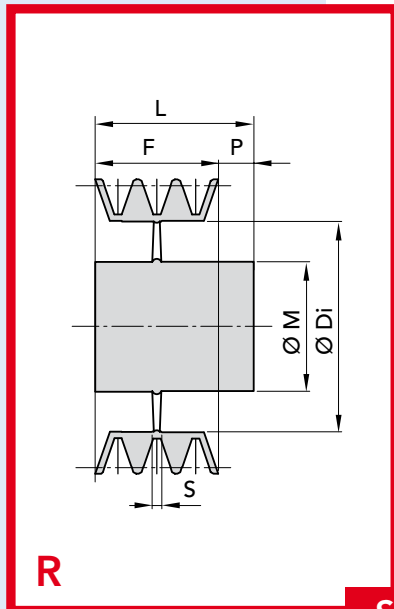

SPOKES



SOLID HUB

SPA TYPE

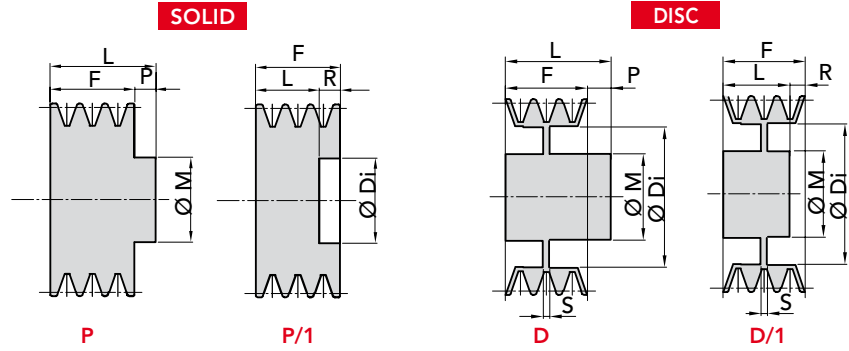

V-PULLEYS PILOT BORE

Dp	P. NUMBER	N°	EXEC.	ØM	L	ØDi	S	F	P	R	WEIGHT
GROOVES											Kg.
											min
40	91220401	1	P	40	35			20	15		0,20
50	91220501	1	P	40	35			20	15		0,30
	91220502	2	P	40	45			35	10		0,40
55	91220551	1	P	40	35			20	15		0,40
	91220552	2	P	40	45			35	10		0,60
60	91220601	1	P	40	35			20	15		0,40
	91220602	2	P	40	45			35	10		0,65
	91220603	3	P	40	50			50			0,90
63	91220631	1	P	40	35			20	20		0,50
	91220632	2	P	40	45			35	10		0,70
	91220633	3	P	40	50			50			0,90
65	91220651	1	P	40	40			20	20		0,50
	91220652	2	P	50	45			35	10		0,75
	91220653	3	P	52	50			50			1,00
70	91220701	1	P	40	40			20	20		0,50
	91220702	2	P	50	45			35	10		0,80
	91220703	3	P	52	50			50			1,10
	91220704	4	P	52	65			65			1,40
	91220705	5	P	52	80			80			1,70
75	91220751	1	P	40	40			20	20		0,50
	91220752	2	P	50	45			35	10		1,10
	91220753	3	P	52	50			50			1,50
	91220754	4	P	52	65			65			2,00
	91220755	5	P	52	80			80			2,50
80	91220801	1	P	45	40			20	20		0,50
	91220802	2	P	50	45			35	10		1,00
	91220803	3	P	62	50			50			1,50
	91220804	4	P	62	65			65			2,00
	91220805	5	P	62	80			80			2,50
85	91220851	1	P	45	40			20	20		0,60
	91220852	2	P	50	45			35	10		1,20
	91220853	3	P	62	50			50			1,80
	91220854	4	P	62	65			65			2,40
	91220855	5	P	62	80			80			3,00
90	91220901	1	P	45	40			20	20		0,80
	91220902	2	P	60	45			35	10		1,40
	91220903	3	P	62	50			50			2,00
	91220904	4	P	68	65			65			2,60
	91220905	5	P	68	80			80			3,20

Dp	P. NUMBER	N°	EXEC.	ØM	L	ØDi	S	F	P	R	WEIGHT
GROOVES											Kg.
											min
95	91220951	1	P	45	40			20	20		0,70
	91220952	2	P	60	45			35	10		1,50
	91220953	3	P	62	50			50			2,30
	91220954	4	P	68	65			65			3,10
	91220955	5	P	68	80			80			3,90
100	91221001	1	P	48	40			20	20		0,80
	91221002	2	P	60	45			35	10		1,30
	91221003	3	P	62	50			50			1,80
	91221004	4	P/1		52	67		65		13	2,25
	91221005	5	P/1		52	67		80		28	2,10
105	91221051	1	P	48	40			20	20		0,80
	91221052	2	P	60	45			35	10		1,60
	91221053	3	P	62	50			50			2,40
	91221054	4	P/1		52	72		65		13	3,13
	91221055	5	P/1		52	72		80		28	3,30
112	91221121	1	P	48	40			20	20		1,00
	91221122	2	P	60	45			35	10		1,70
	91221123	3	P	62	50			50			2,40
	91221124	4	P/1		52	79		65		13	2,64
	91221125	5	P/1		52	79		80		28	2,80
120	91221201	1	P	60	40			20	20		1,20
	91221202	2	P	60	50			35	15		1,85
	91221203	3	P	70	50			50			2,40
	91221204	4	P/1		52	87		65		13	2,93
	91221205	5	P/1		52	87		80		28	3,70
125	91221251	1	P	60	40			20	20		1,30
	91221252	2	P	60	50			35	15		1,90
	91221253	3	P	70	50			50			2,50
	91221254	4	P/1		52	92		65		13	3,10
130	91221301	1	P	60	45			20	20		1,40
	91221302	2	P	60	45			35	10		2,20
	91221303	3	P	70	52			50			3,00
	91221304	4	P/1		52	97		65		13	3,10
	91221305	5	P/1		52	97		80		28	2,80
140	91221401	1	D	60	40	107	10	20	20		1,50
	91221402	2	D	60	50	107	10	35	15		2,00
	91221403	3	D	70	52	107	12	50	2		2,50
	91221404	4	P/1		52	107		65		13	2,70
	91221405	5	P/1		52	107		80		28	1,70
150	91221501	1	D	60	40	107	10	20	20		1,60
	91221502	2	D	60	45	107	10	35	10		2,50
	91221503	3	D	70	52	107	12	50	2		3,60
	91221504	4	P/1		52	107		65		13	4,40
	91221505	5	P/1		52	107		80		28	4,00

MATERIAL CAST-IRON



V-PULLEYS PILOT BORE

SOLID HUB

SPA TYPE

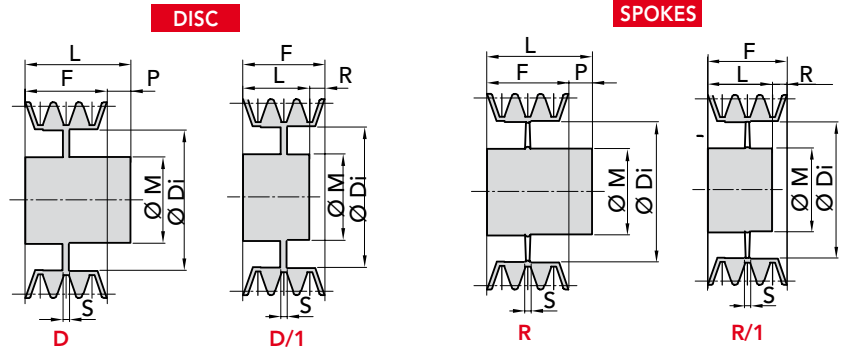

Dp	P. NUMBER	N°	EXEC.	ØM	L	ØDi	S	F	P	R	WEIGHT	
GROOVES												
											min	Kg.
160	91221601	1	D	60	40	127	10	20	20		1,70	
	91221602	2	D	60	50	127	10	35	15		2,40	
	91221603	3	D	70	52	127	12	50	2		2,80	
	91221604	4	D/1	70	52	127	18	65		13	2,45	
	91221605	5	D/1	80	52	127	18	80		28	3,20	
170	91221701	1	D	60	40	137	12	20	20		2,00	
	91221702	2	D	60	45	137	12	35	10		2,90	
	91221703	3	D	70	52	137	12	50	2		3,80	
	91221704	4	D/1	80	52	137	18	65		13	4,10	
	91221705	5	D/1	80	52	137	18	80		28	4,60	
180	91221801	1	D	65	40	147	12	20	20		2,50	
	91221802	2	D	70	50	147	12	35	15		3,10	
	91221803	3	D	70	52	147	12	50	2		4,20	
	91221804	4	D/1	80	60	147	18	65		5	4,80	
	91221805	5	D/1	80	65	147	18	80		15	5,00	
190	91221902	2	D	70	50	157	12	35	15		3,20	
200	91222001	1	D	65	45	167	12	20	25		2,70	
	91222002	2	D	70	50	167	12	35	15		3,70	
	91222003	3	D	70	50	167	12	50		5	4,80	
	91222004	4	D/1	80	60	167	18	65		15	5,50	
	91222005	5	D/1	80	65	167	18	80			5,80	
225	91222251	1	D	65	45	192	12	20	25		3,00	
	91222252	2	D	70	50	192	12	35	15		3,80	
	91222253	3	D	80	50	192	12	50		5	5,00	
	91222254	4	D/1	90	60	192	18	65		15	5,60	
	91222255	5	D/1	90	65	192	18	80			6,00	
250	91222501	1	D	75	50	217	12	20	30		3,70	
	91222502	2	D	75	50	217	12	35	15		4,30	
	91222503	3	D	80	60	217	12	50	10		4,60	
	91222504	4	D	90	65	217	18	65		15	6,10	
	91222505	5	D/1	90	65	217	18	80			6,20	
280	91222801	1	R	75	50	247	14	20	30		3,90	
	91222802	2	R	80	50	247	14	35	15		5,30	
	91222803	3	R	80	60	247	14	50	10		6,70	
	91222804	4	R	90	65	247	14	65		15	8,10	
	91222805	5	R/1	100	65	247	14	80			8,80	
300	91223001	1	R	75	50	267	14	20	30		4,20	
	91223002	2	R	80	50	267	14	35	15		5,90	
	91223003	3	R	80	60	267	14	50	10		7,60	
	91223004	4	R	90	70	267	14	65	5	10	9,30	
	91223005	5	R/1	100	70	267	14	80			10,3	
315	91223152	2	R	80	50	282	14	35	15		6,60	

MATERIAL **CAST-IRON**

CAD drawings available on our site
www.chiaravalli.com

Quantity, availability and prices
 on B2B Chiaravalli



SOLID HUB

SPB TYPE

SOLID

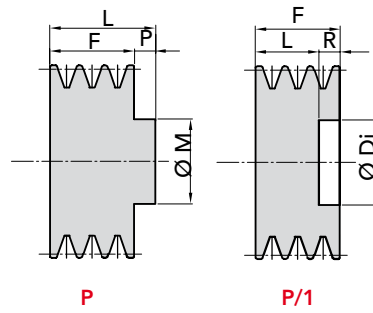

DISC

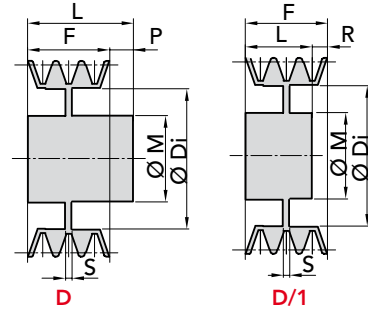

V-PULLEYS PILOT BORE

Dp	P. NUMBER	N°	EXEC.	ØM	L	ØDi	S	F	P	R	WEIGHT	Dp	P. NUMBER	N°	EXEC.	ØM	L	ØDi	S	F	P	R	WEIGHT
GROOVES												GROOVES											
min												min											
Kg.												Kg.											
60	91320603	3	P	50	67			63	4		1,70	130	91321301	1	P	60	45			25	20		2,00
70	91320701	1	P	45	45			25	20		0,70		91321302	2	P	60	55			44	11		2,60
	91320702	2	P	45	55			44	11		1,40		91321303	3	P/1	60	88			63	3		4,20
	91320703	3	P		63			63			2,10		91321304	4	P/1	60	88			82	22		5,00
	91320704	4	P		82			82			2,50		91321305	5	P/1	60	88			101	41		5,50
	91320705	5	P		101			101			3,00	140	91321401	1	P	65	45			25	20		2,10
80	91320801	1	P	50	45			25	20		1,00		91321402	2	P	65	55			44	11		2,90
	91320802	2	P	50	55			44	11		1,60		91321403	3	P/1	60	98			63	3		4,40
	91320803	3	P	50	63			63			2,20		91321404	4	P/1	60	98			82	22		5,30
	91320804	4	P		82			82			2,80		91321405	5	P/1	60	98			101	41		5,74
	91320805	5	P		101			101			3,40		91321406	6	P/1	60	98			120	60		6,74
90	91320901	1	P	50	45			25	20		1,10	150	91321501	1	P	65	45			25	20		2,40
	91320902	2	P	50	55			44	11		1,70		91321502	2	P	65	55			44	11		3,20
	91320903	3	P		63			63			2,30		91321503	3	P/1	60	108			63	3		4,60
	91320904	4	P		82			82			2,90		91321504	4	P/1	60	108			82	22		5,50
	91320905	5	P		101			101			3,50		91321505	5	P/1	60	108			101	41		6,00
100	91321001	1	P	52	45			25	20		1,30		91321506	6	P/1	60	108			120	60		7,00
	91321002	2	P	55	55			44	11		1,80	160	91321601	1	D	65	45	118	12	25	20		2,50
	91321003	3	P		63			63			2,90		91321602	2	D	70	55	118	12	44	11		3,30
	91321004	4	P		82			82			3,70		91321603	3	P/1	60	118			63	3		4,80
	91321005	5	P		101			101			4,50		91321604	4	P/1	60	118			82	22		5,70
112	91321121	1	P	55	45			25	20		1,50		91321605	5	P/1	60	118			101	41		7,00
	91321122	2	P	60	55			44	11		1,90		91321606	6	P/1	65	118			120	55		8,30
	91321123	3	P		63			63			3,50	170	91321701	1	D	65	45	128	12	25	20		2,80
	91321124	4	P		82			82			4,70		91321702	2	D	70	55	128	12	44	11		3,40
	91321125	5	P		101			101			4,80		91321703	3	P/1	60	128			63	3		5,10
120	91321201	1	P	55	45			25	20		1,70		91321704	4	P/1	60	128			82	22		5,92
	91321202	2	P	60	55			44	11		2,10		91321705	5	P/1	60	128			101	41		7,30
	91321203	3	P		63			63			3,80		91321706	6	P/1	65	128			120	55		8,70
	91321204	4	P		82			82			4,20	180	91321801	1	D	65	45	138	12	25	20		3,10
	91321205	5	P		101			101			5,00		91321802	2	D	70	55	138	12	44	11		3,90
125	91321251	1	P	58	45			25	20		1,90		91321803	3	D/1	80	60	138	18	63	3		5,20
	91321252	2	P	60	55			44	11		2,40		91321804	4	P/1	60	138			82	22		6,18
	91321253	3	P/1	60	83			63	3		4,00		91321805	5	P/1	70	138			101	31		7,40
	91321254	4	P/1	60	83			82	22		4,70		91321806	6	P/1	70	138			120	50		8,70
	91321255	5	P/1	60	83			101	41		5,20												

MATERIAL CAST-IRON



V-PULLEYS PILOT BORE

SOLID HUB

SPB TYPE

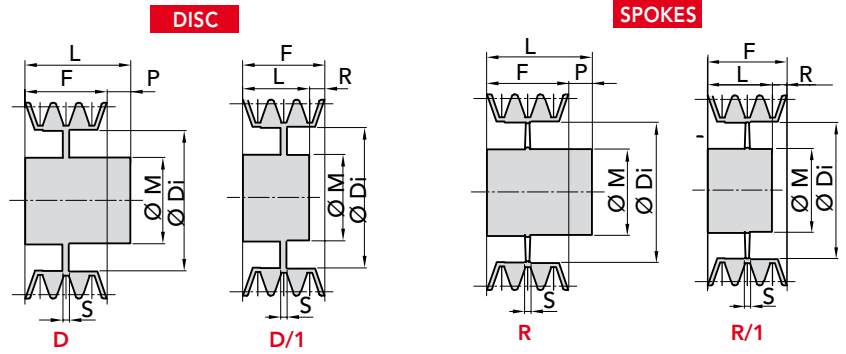

Dp	P. NUMBER	N°	EXEC.	ØM	L	ØDi	S	F	P	R	WEIGHT	Dp	P. NUMBER	N°	EXEC.	ØM	L	ØDi	S	F	P	R	WEIGHT
GROOVES												GROOVES											
min												min											
Kg.												Kg.											
200	91322001	1	D	70	45	158	14	25	20		3,40	315	91323151	1	R	76	50	273	15	25	25		6,40
	91322002	2	D	70	55	158	14	44	11		4,40		91323152	2	R	88	60	273	15	44	16		8,20
	91322003	3	D/1	88	60	158	18	63		3	5,80		91323153	3	R/1	90	60	273	18	63		3	14,0
	91322004	4	D/1	88	60	158	25	82		22	6,77		91323154	4	R/1	96	65	273	20	82		17	17,0
	91322005	5	D/1	96	70	158	25	101		31	8,17		91323155	5	R/1	104	75	273	22	101		26	19,0
	91322006	6	D/1	96	80	158	25	120		50	9,57		91323156	6	R/1	120	90	273	22	120		30	24,0
212	91322121	1	D	70	45	170	14	25	20		3,70	340	91323401	1	R	80	50	298	15	25	25		6,70
	91322122	2	D	77	55	170	14	44	11		4,60		91323402	2	R	88	60	298	15	44	16		12,5
	91322123	3	D/1	88	60	170	18	63		3	6,00		91323403	3	R/1	92	60	298	18	63		3	15,0
	91322124	4	D/1	88	60	170	25	82		22	7,00		91323404	4	R/1	96	65	298	20	82		17	19,0
	91322125	5	D/1	96	70	170	25	101		31	8,60		91323405	5	R/1	104	75	298	22	101		26	20,0
	91322126	6	D/1	104	80	170	25	120		40	10,0		91323406	6	R/1	120	90	298	22	120		30	28,0
224	91322244	4	D/1	88	60	182	25	82		22	3,85	355	91323551	1	R	80	50	313	16	25	25		7,00
225	91322251	1	D	70	45	183	14	25	20		4,00		91323552	2	R	88	60	313	18	44	16		13,0
	91322252	2	D	77	55	183	14	44	11		5,40		91323553	3	R/1	92	60	313	22	63		3	16,0
	91322253	3	D/1	88	60	183	18	63		3	6,90		91323554	4	R/1	96	65	313	22	82		17	19,0
	91322254	4	D/1	88	60	183	25	82		22	7,83		91323555	5	R/1	104	75	313	24	101		26	21,0
	91322255	5	D/1	96	70	183	25	101		31	9,33		91323556	6	R/1	120	90	313	24	120		30	29,0
	91322256	6	D/1	104	80	183	25	120		40	10,83	380	91323801	1	R	85	55	338	20	25	30		8,00
236	91322364	4	D/1	88	60	194	25	82		22	8,10		91323802	2	R	88	60	338	20	44	16		13,5
250	91322501	1	D	70	50	208	14	25	25		4,20		91323803	3	R	96	65	338	22	63	2		17,0
	91322502	2	D	77	55	208	14	44	11		6,10		91323804	4	R/1	104	75	338	24	82		7	20,0
	91322503	3	D/1	88	60	208	18	63		3	8,60		91323805	5	R/1	112	85	338	24	101		16	23,0
	91322504	4	D/1	96	65	208	25	82		17	10,36		91323806	6	R/1	120	100	338	28	120		20	30,0
	91322505	5	D/1	104	75	208	25	101		26	12,86	400	91324001	1	R	85	55	358	20	25	30		9,80
	91322506	6	D/1	104	80	208	25	120		40	15,36		91324002	2	R	88	60	358	20	44	16		14,0
280	91322801	1	R	76	50	238	14	25	25		5,70		91324003	3	R	96	65	358	22	63	2		18,0
	91322802	2	R	80	55	238	14	44	11		7,00		91324004	4	R/1	104	75	358	24	82		7	21,0
	91322803	3	R/1	90	60	238	18	63		3	9,60		91324005	5	R/1	112	85	358	24	101		16	24,0
	91322804	4	R/1	96	65	238	25	82		17	12,06		91324006	6	R/1	120	100	358	28	120		20	32,0
	91322805	5	R/1	104	75	238	25	101		26	13,91	425	91324503	3	R	96	65	383	24	63	2		19,0
	91322806	6	R/1	104	80	238	25	120		40	17,0		91324504	4	R/1	104	75	383	24	82		7	22,0
300	91323001	1	R	76	50	258	15	25	25		6,50		91324505	5	R/1	112	85	383	28	101		16	26,0
	91323002	2	R	80	55	258	15	44	11		7,50		91324256	6	R/1	120	100	385	28	120		20	35,0
	91323003	3	R/1	90	60	258	18	63		3	12,0												
	91323004	4	R/1	96	65	258	20	82		17	16,0												
	91323005	5	R/1	104	75	258	22	101		26	19,0												
	91323006	6	R/1	104	80	258	22	120		40	23,0												

MATERIAL **CAST-IRON**



SOLID HUB

SPB TYPE

SPOKES

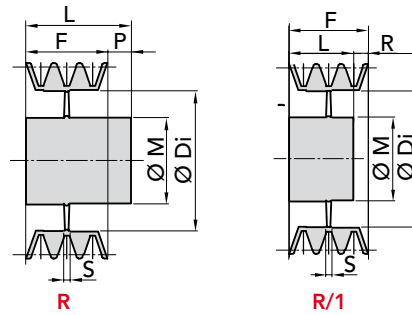

V-PULLEYS PILOT BORE

Dp	P. NUMBER	N°	EXEC.	ØM	L	ØDi	S	F	P	R	WEIGHT
GROOVES				min			Kg.				
450	91324501	1	R	90	60	408	20	25	35		10,00
	91324502	2	R	90	6a0	408	20	44	16		14,50
	91324503	3	R	96	65	408	24	63	2		22,00
	91324504	4	R/1	104	75	408	26	82		7	25,00
	91324505	5	R/1	112	85	408	26	101		16	28,50
	91324506	6	R/1	120	100	408	30	120		20	36,00
500	91325001	1	R	100	60	458	20	25	35		11,00
	91325002	2	R	100	65	458	20	44	21		15,00
	91325003	3	R	104	75	458	24	63	12		24,00
	91325004	4	R	112	85	458	26	82	3		27,50
	91325005	5	R/1	120	90	458	30	101		11	31,00
	91325006	6	R/1	129	105	458	30	120		15	39,00
560	91325601	1	R	100	60	518	20	25	35		15,00
	91325602	2	R	100	65	518	20	44	21		17,00
	91325603	3	R	104	75	518	24	63	12		29,50
	91325604	4	R	112	85	518	26	82	3		34,00
	91325605	5	R/1	120	90	518	30	101		11	36,00
	91325606	6	R/1	128	105	518	35	120		15	48,00
600	91326001	1	R	100	60	558	22	25	35		16,00
	91326002	2	R	100	65	558	22	44	21		18,00
	91326003	3	R	104	75	558	28	63	12		31,00
	91326004	4	R	115	85	558	28	82	3		35,00
	91326005	5	R/1	120	90	558	30	101		11	42,00
	91326006	6	R/1	128	105	558	35	120		15	49,00
630	91326301	1	R	100	60	588	22	25	35		18,00
	91326302	2	R	100	65	588	28	44	21		19,00
	91326303	3	R	104	75	588	28	63	12		33,00
	91326304	4	R	120	85	588	32	82	3		36,00
	91326305	5	R/1	128	90	588	32	101		11	48,00

ON DEMAND
ON DEMAND

MATERIAL CAST-IRON

CAD drawings available on our site
www.chiaravalli.com

Quantity, availability and prices
on B2B Chiaravalli



SOLID HUB

SPC TYPE

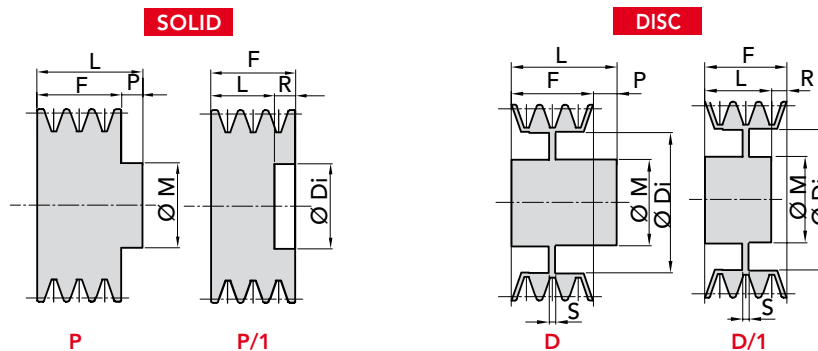

Dp	P. NUMBER	N°	EXEC.	ØM	L	ØDi	S	F	P	R	WEIGHT	
				GROOVES		min				Kg.		
120	91421201	1	P	65	50			34	16		2,30	
	91421202	2	P	65	65			59,5	5,5		2,60	
	140	91421401	1	P	70	55			34	21		2,10
		91421402	2	P		59,5			59,5			2,90
		91421403	3	P/1		65	83		85	20		3,90
91421404	4	P/1		80	83		111	30,5		4,74		
150	91421501	1	P	70	50			34	16		3,10	
	91421502	2	P	72	59,5			59,5			3,90	
	91421503	3	P/1		65	93		85	20		4,70	
	91421504	4	P/1		80	93		111	30,5		5,70	
	91421505	5	P/1		96	93		136	40		6,70	
160	91421601	1	P	72	50			34	16		3,70	
	91421602	2	P		59,5			59,5			4,60	
	91421603	3	P/1		65	103		85	20		5,70	
	91421604	4	P/1		80	103		111	30,5		7,00	
	91421605	5	P/1		96	103		136	40		8,30	
180	91421801	1	D	76	50	123	16	34	16		3,10	
	91421802	2	D	80	60	123	16	59,5	0,5		3,90	
	91421803	3	D/1	82	65	123	18	85	20		5,20	
	91421804	4	D/1	82	80	123	20	111	30,5		6,18	
	91421805	5	D/1	82	96	123	20	136	40		7,48	
200	91422001	1	D	76	50	143	16	34	16		3,40	
	91422002	2	D	80	60	143	16	59,5	0,5		4,80	
	91422003	3	D/1	86	65	143	18	85	20		5,80	
	91422004	4	D/1	90	90	143	25	111	20,5		6,70	
	91422005	5	D/1	90	100	143	25	136	36		8,70	
225	91422251	1	D	86	50	168	18	34	16		5,50	
	91422252	2	D	88	60	168	18	59,5	0,5		6,90	
	91422253	3	D/1	90	70	168	25	85	15		7,83	
	91422254	4	D/1	90	90	168	25	111	20,5		9,33	
	91422255	5	D/1	90	100	168	25	136	36		10,83	
250	91422501	1	D	86	50	193	18	34	16		7,30	
	91422502	2	D	92	60	193	18	59,5	0,5		8,60	
	91422503	3	D/1	92	70	193	25	85	15		10,36	
	91422504	4	D/1	100	90	193	25	111	20,5		12,86	
	91422505	5	D/1	102	100	193	25	136	36		15,36	

Dp	P. NUMBER	N°	EXEC.	ØM	L	ØDi	S	F	P	R	WEIGHT
				GROOVES		min				Kg.	
280	91422801	1	D	86	50	223	18	34	16		7,00
	91422802	2	D	92	60	223	18	59,5	0,5		9,60
	91422803	3	D/1	92	70	223	25	85	15		12,0
	91422804	4	D/1	100	90	223	25	111	20,5		13,9
	91422805	5	D/1	102	100	223	25	136	36		15,2
300	91423001	1	D	86	50	243	20	34	16		7,50
	91423002	2	D	92	60	243	20	59,5	0,5		8,90
	91423003	3	D/1	92	70	243	25	85	15		9,80
	91423004	4	D/1	100	90	243	25	111	20,5		10,7
	91423005	5	D/1	104	100	243	25	136	36		11,24

MATERIAL CAST-IRON

CAD drawings available on our site
www.chiaravalli.com

Quantity, availability and prices
 on B2B Chiaravalli

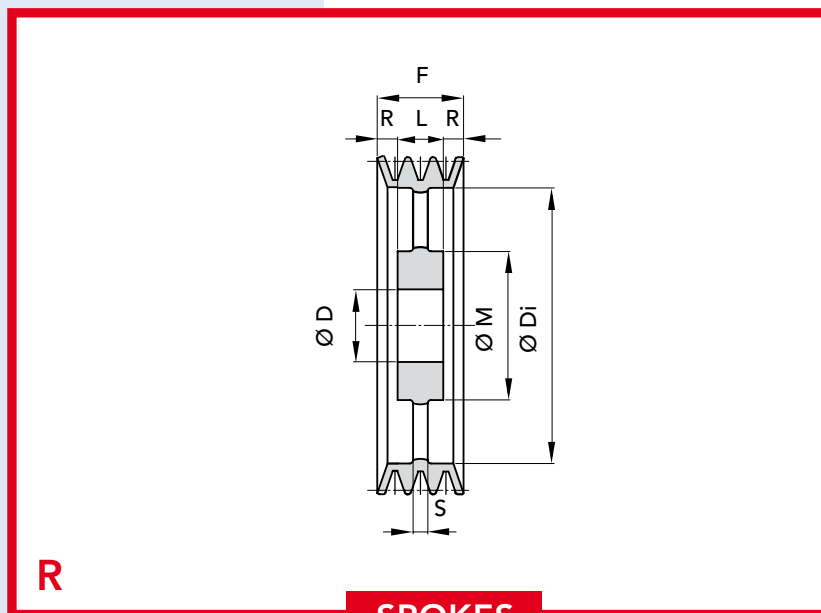
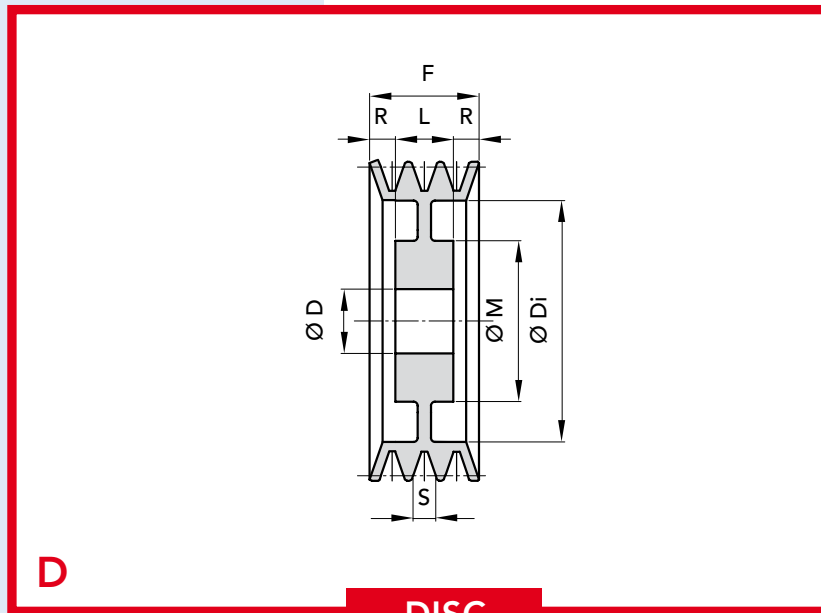
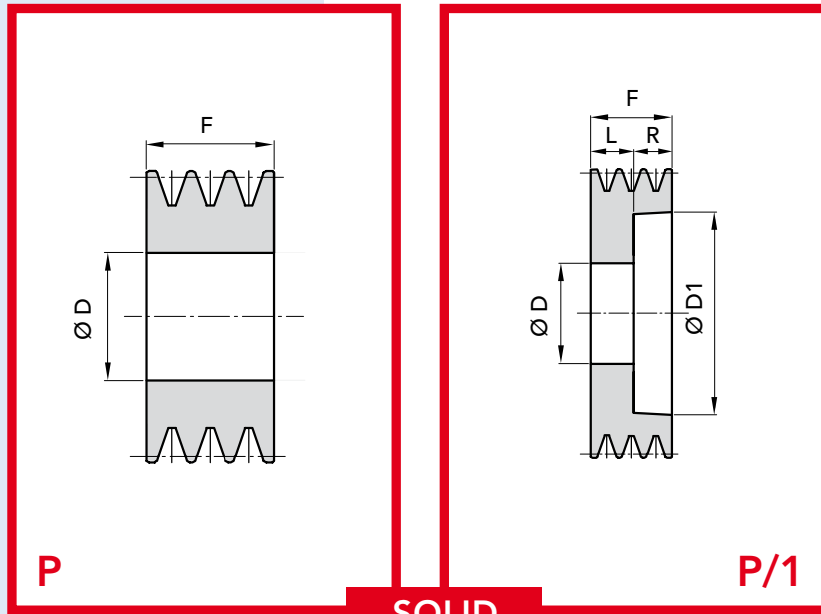



for LOCKING DEVICES

SPA TYPE

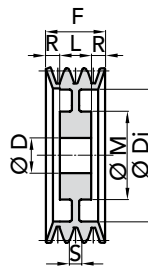
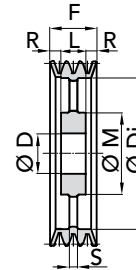
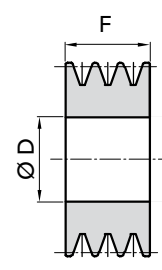
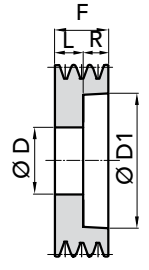
DISC

D
SPOKES

R
SOLID

P

P/1

Dp	P. NUMBER Ø 55 H8	P. NUMBER Ø 65 H8	P. NUMBER Ø 80 H8	N° GROOVES	EXEC.	F	L	Ø M	R	Ø Di	S	WEIGHT Kg.
90	91250902			2	P	35						0,20
	91250903			3	P	50						1,10
	91250905			5	P	80						2,00
95	91250952			2	P	35						0,85
100	91251001			1	P	20						0,50
	91251002	91261002		2	P	35						0,90
	91251003			3	P	50						1,30
105	91251052			2	P	35					0,95	
120	91251202			2	P/1	35	27		8	88		1,00
125		91261252		2	P/1	35	27		8	92		1,00
		91261253		3	P/1	50	27		23	92		1,80
		91261254		4	P/1	65	27		38	92		2,40
130		91261303		3	P/1	50	27		23	97		1,75
140		91261403		4	P/1	65	27		38	107		1,50
150	91251502			2	P/1	35	27		8	117		1,35
		91261504		4	P/1	65	27		38	117		2,15
160	91251602	91261602		2	P/1	35	27		8	127		1,50
		91261603		3	P/1	50	27		23	127		1,90
170	91251702			2	D	35	27		4	137	27	1,60
180	91251802	91261802		2	D	35	27		4	147	27	1,70
	91251803	91271803		3	D	50	27		11,5	147	27	2,40
190		91261902		2	D	35	27	120	4	157	12	1,80
		91261903		3	D	50	27	120	11,5	157	12	2,50
200	91252002	91262002		2	D	35	27	120	4	167	12	1,90
		91262003		3	D	50	27	120	11,5	167	14	2,60
		91262004		4	D	65	27	120	19	167	14	3,30
225	91252252	91262252		2	D	35	27	120	4	192	12	2,20
		91262253		3	D	50	27	120	11,5	192	14	2,80
250	91252502			2	R	35	27	130	4	217	14	2,80
			91282503	3	R	50	27	130	11,5	217	14	3,50
		91262504		4	R	65	27	130	19	217	14	4,20
300			91283004	4	R	65	27	130	19	267	14	3,40

 MATERIAL **CAST-IRON**

 CAD drawings available on our site
www.chiaravalli.com

 Quantity, availability and prices
 on B2B Chiaravalli



for LOCKING DEVICES

SPB TYPE

DISC

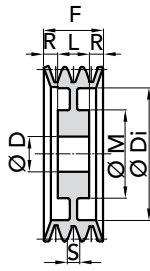

D

SPOKES

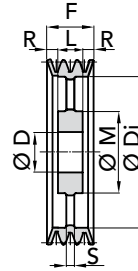

R

SOLID

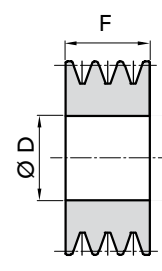

P

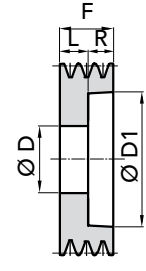

P/1

Dp	P. NUMBER Ø 55 H8	P. NUMBER Ø 65 H8	P. NUMBER Ø 80 H8	N° GROOVES	EXEC.	F	L	Ø M	R	Ø Di	S	WEIGHT Kg.
112	91351121			1	P	25						1,50
	91351122			2	P/1	44	27		17	70		1,90
120		91361202		2	P/1	44	27		17	78		2,10
		91361203		3	P/1	63	27		36	78		3,80
		91361204		4	P/1	82	27		55	78		4,20
125	91351251			1	P	25						1,90
		91371252		2	P/1	44	27		17	83		2,40
		91361253		3	P/1	63	27		36	83		4,00
130		91361302	91381302	2	P/1	44	27		17	90		2,60
		91361303	91381303	3	P/1	63	27		36	90		4,20
		91361304	91381304	4	P/1	82	27		55	90		5,00
			91381305	5	P/1	101	27		74	90		5,50
			91381306	6	P/1	120	27		93	90		6,00
140	91351402	91361402	91381402	2	P/1	44	27		17	98		2,90
		91361403	91381403	3	P/1	63	27		36	98		4,40
		91361404	91381404	4	P/1	82	27		55	98		5,30
			91381405	5	P/1	101	27		74	98		5,80
150	91351501	91361501		1	P	25						2,40
	91351502	91361502	91381502	2	P/1	44	27		17	108		3,20
		91361503	91381503	3	P/1	63	27		36	108		4,60
		91361504	91381504	4	P/1	82	27		55	108		5,50
			91381505	5	P/1	101	27		74	108		6,00
160	91351601	91361601		1	P	25						2,50
		91361602	91381602	2	P/1	44	27		17	118		3,30
		91361603	91381603	3	P/1	63	27		36	118		4,80
			91381604	4	P/1	82	27		55	118		5,70
			91381605	5	P/1	101	27		74	118		7,00
			91381606	6	P/1	120	27		93	118		8,30
170			91381702	2	D	44	27		8,5	128	27	3,40
		91361703	91381703	3	D	63	27		18	128	27	5,10
			91381704	4	D	82	27		27,5	128	27	5,90
			91381705	5	D	101	27		37	128	27	7,40
180				1	P	25						3,10
		91361802	91381802	2	D	44	27		8,5	138	27	3,90
		91361803	91381803	3	D	63	27		18	138	27	5,20
		91361804	91381804	4	D	82	27		27,5	138	27	6,20
			91381805	5	D	101	27		37	138	27	7,50
			91381806	6	D	120	27		46,5	138	27	8,90

V-BELT PULLEYS for LOCKING DEVICES SPB

MATERIAL **CAST-IRON**

CAD drawings available on our site
www.chiaravalli.com

Quantity, availability and prices
 on B2B Chiaravalli

for LOCKING DEVICES
SPB TYPE

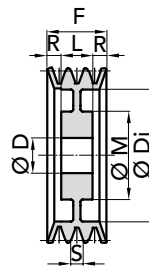
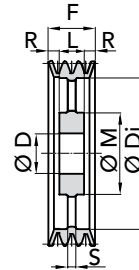
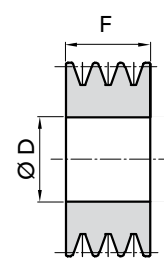
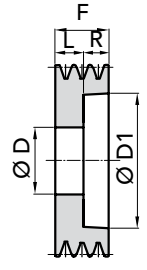
DISC

D
SPOKES

R
SOLID

P

P/1

Dp	P. NUMBER Ø 55 H8	P. NUMBER Ø 65 H8	P. NUMBER Ø 80 H8	N° GROOVES	EXEC.	F	L	Ø M	R	Ø Di	S	WEIGHT Kg.
190		91361901	91381902	1	P	25						3,50
			91381903	2	D	44	27		8,5	148	27	6,50
			91381904	3	D	63	27		18	148	27	7,00
			91381905	4	D	82	27		27,5	148	27	8,00
				5	D	101	27		37	148	27	9,00
200		91362001 91372002 91362003 91362004	91382001	1	P	25						4,00
			91382002	2	D	44	27	120	8,5	158	15	7,00
			91382003	3	D	63	27	120	18	158	15	8,00
			91382004	4	D	82	27	120	27,5	158	15	9,00
			91382005	5	D	101	27	120	37	158	15	10,0
			91382006	6	D	120	27	120	46,5	158	18	11,0
212		91362122 91362123 91362124	91382122	2	D	44	27	120	8,5	170	15	7,00
			91382123	3	D	63	27	120	18	170	15	8,50
			91382124	4	D	82	27	120	27,5	170	15	10,0
			91382125	5	D	101	27	120	37	170	15	11,0
225	91352253	91372252 91362253 91362254	91382252	2	D	44	27	120	8,5	183	15	7,70
			91382253	3	D	63	27	120	18	183	15	9,00
			91382254	4	D	82	27	120	27,5	183	15	10,5
			91382255	5	D	101	27	120	37	183	15	11,5
			91382256	6	D	120	27	120	46,5	183	18	13,0
240			91382403	3	D	63	27	120	18	198	16	11,0
250	91352501 91352502	91372502 91372503 91362504	91382502	1	D	25	25	130		208	16	6,20
			91382503	2	D	44	27	130	8,5	208	16	8,50
			91382504	3	D	63	27	130	18	208	16	11,0
			91382505	4	D	82	27	130	27,5	208	16	12,0
			91382506	5	D	101	27	130	37	208	16	18,0
				6	D	120	27	130	46,5	208	18	22,0
280			91382802	1	D	25	25	120		238	16	6,50
			91382803	2	D	44	27	120	8,5	238	16	10,0
			91382804	3	D	63	27	120	18	238	16	12,5
			91382805	4	D	82	27	120	27,5	238	16	14,0
				5	D	101	27	130	37	238	16	21,0
300	91353001		91383004	1	R	25	25	130		258	15	7,00
			91383005	4	R	82	27	130	27,5	258	20	16,0
				5	R	101	27	130	37	258	22	19,0
315		91363153	91383154	3	R	63	27	130	18	273	18	14,0
			91383155	4	R	82	27	130	27,5	273	20	20,0
				5	R	101	27	130	37	273	22	22,0
355	91353551			1	R	25	25	130		308	16	16,0

MATERIAL CAST-IRON

 CAD drawings available on our site
www.chiaravalli.com

 Quantity, availability and prices
 on B2B Chiaravalli



for LOCKING DEVICES

SPC TYPE

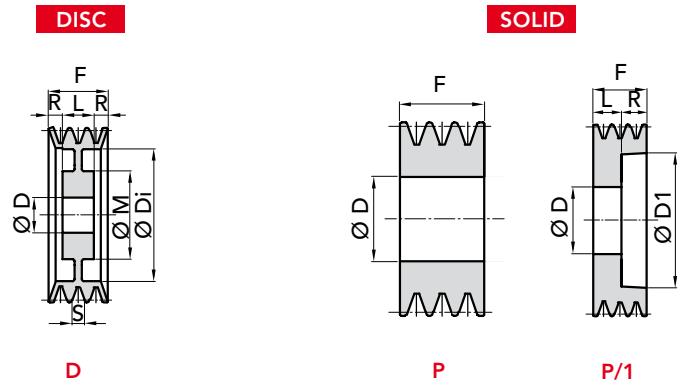

Dp	P. NUMBER Ø 55 H8	P. NUMBER Ø 65 H8	P. NUMBER Ø 80 H8	N° GROOVES	EXEC.	F	L	Ø M	R	Ø Di	S	WEIGHT Kg.
160			91481603	3	P/1	85	27		58	103		2,60
190			91481903	3	P/1	85	27		58	133		2,90
225			91482253	3	D	85	27	120	29	168	25	3,40

V-BELT PULLEYS for LOCKING DEVICES SPC

MATERIAL **CAST-IRON**

CAD drawings available on our site
www.chiaravalli.com

Quantity, availability and prices
 on B2B Chiaravalli

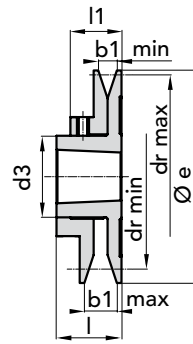

EXECUTION 1

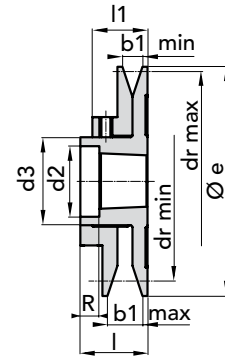

EXECUTION 2

PULLEY TYPE	P. NUMBER	EXEC.	N° GROOVES	BUSHE	Ø e	l	l1	b1		dr		d2	d3	R	GRUB DIN 916 UNI 5929	SECTION BELT	WEIGHT Kg.
								min	max	min	max						
PRB - 93	90000931	2	1	1108	93	36,5	29	10	17,5	57 59	78 85	46	M60x2	13,5	No.4 M6x6	Z 10x6 A 13x8	0,86
PRB - 108	90001081	1	1	1215	108	38	30,5	10	17,5	68 70 75 76	92 100 93 102	-	M72x2	-	No.4 M6x6	Z 10x6 A 13x8 SPZ SPA	1,18
PRB - 120	90001201	1	1	1215	120	38	30,5	10	17,5	80 82 87 88	104 112 105 114	-	M72x2	-	No.4 M6x6	Z 10x6 A 13x8 SPZ SPA	1,46
PRB - 138	90001381	1	1	1615	138	38	30,5	10	17,5	98 100 105 106	122 130 123 132	-	M85x2	-	No.4 M6x6	Z 10x6 A 13x8 SPZ SPA	2,00
PRB - 160	90001601	2	1	1615	160	45	35,5	13	22,5	108 112 114 117	138 150 140 153	69	M85x2	6,5	No.4 M8x8	A 13x8 B 17x11 SPA SPB	3,04
PRB - 180	90001801	2	1	2012	180	45	35,5	13	22,5	128 132 134 137	158 170 160 173	87	M110x2	12,5	No.4 M8x8	A 13x8 B 17x11 SPA SPB	3,80
PRB - 200	90002001	2	1	2012	200	45	35,5	13	22,5	149 152 155 159	177 190 179 193	87	M110x2	12,5	No.4 M8x8	A 13x8 B 17x11 SPA SPB	4,75

MATERIAL **CAST-IRON G20**
UNI 5007

CAD drawings available on our site
www.chiaravalli.com

Quantity, availability and prices
on B2B Chiaravalli

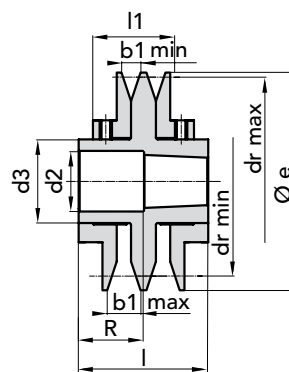

EXECUTION 3

PULLEY TYPE	P. NUMBER	EXEC. N°	BUSHE GROOVES	Ø e	l	l1	b1		dr		d2	d3	R	GRUB DIN 916 UNI 5929	SECTION BELT	WEIGHT Kg.	
							min	max	min	max							
PRB2 - 108	90001082	3	2	1215	108	73	58	10	17,5	68	92	57	M72x2	34,5	No. 8 M6x6	Z 10x6 A 13x8 SPZ SPA	2,40
										70	100						
										75	93						
										76	102						
PRB2 - 120	90001202	3	2	1215	120	73	58	10	17,5	80	104	57	M72x2	34,5	No. 8 M6x6	Z 10x6 A 13x8 SPZ SPA	2,65
										82	112						
										87	105						
										88	114						
PRB2 - 138	90001382	3	2	1615	138	73	58	10	17,5	98	122	69	M85x2	34,5	No. 8 M6x6	Z 10x6 A 13x8 SPZ SPA	3,60
										100	130						
										105	123						
										106	132						
PRB2 - 160	90001602	3	2	1615	160	87	68	13	22,5	108	138	69	M85x2	48,5	No. 8 M8x8	A 13x8 B 17x11 SPA SPB	5,60
										112	150						
										114	140						
										117	153						
PRB2 - 180	90001802	3	2	2012	180	87	68	13	22,5	128	158	87	M110x2	54	No. 8 M8x8	A 13x8 B 17x11 SPA SPB	7,15
										132	170						
										134	160						
										137	173						
PRB2 - 200	90002002	3	2	2012	200	87	68	13	22,5	149	177	87	M110x2	54	No. 8 M8x8	A 13x8 B 17x11 SPA SPB	8,92
										152	190						
										155	179						
										159	193						

MATERIAL **CAST-IRON G20**
UNI 5007

CAD drawings available on our site
www.chiaravalli.com

Quantity, availability and prices
on B2B Chiaravalli



TYPES

Grooved pulleys designed for industrial transmissions are identified by reference to the dimensions and the groove pitch in the following types: **PPV-J – PPV-L**

PROFILE DIMENSIONS

The transverse profile dimensions of a grooved pulley are shown in the figure and in the table.

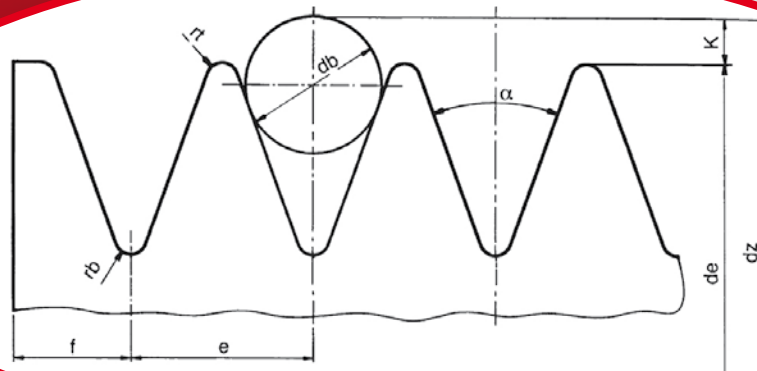

TABLE

TYPE	PPV-J	PPV-L
Grooves pitch e	2.34	4.70
Tolerance for e*	± 0.03	± 0.05
Sum of tolerances e**	± 0.30	± 0.30
Race angle a** ±0,5	40°	40°
rt min.	0.20	0.40
rb max	0.40	0.40
Diameter of the control sphere or roller db ± 0.01	1.50	3.50
2K** nominal	0.23	2.36
f min.	1.8	3.3

* = this tolerance applies to the distance between the axes of two consecutive grooves

** = the sum of all the tolerances "e" for all the races of each pulley must not exceed the value foreseen in the table

* = the axis of each groove must form a $90^\circ \pm 0.5^\circ$ angle with the pulley axis

** = K is not in relation to the pulley's nominal diameter but is measured from the position of the measurement sphere or roller.



PITCH LINE DIAMETER

The position of a grooved belt in contact with the corresponding pulley is shown in cross-section in the figure.

The real pitch line diameter **dp** of a grooved pulley measured along the belt is slightly greater than the actual diameter **de** and the exact value depends on the type of belt used.

For the purposes of illustration, the table shows the value **be** normally adopted to calculate the transmission ratio.

In practice it is sufficient to use the actual diameter **de** to calculate the transmission ratio.

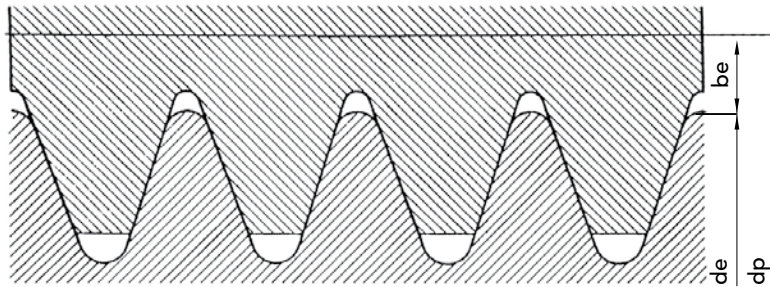

$$dp \cong de + 2be$$

TYPE	PPV-J	PPV-L
2 be	2	5

DESIGNATION

The designation includes the following details, in the order given: the "pulley" domination, the reference of the current standard, the number of grooves, the type and the actual diameter expressed in millimetres.

An example of the designation for a PPV-J type grooved pulley designed for industrial transmissions with 8 grooves and an actual diameter of 200mm

8 PPV-J 200

DEGREE OF FINISH OF THE GROOVES

The surface roughness of the grooves shall be Ra 3.2 in compliance with ISO 254.

MATERIALS

C45 UNI 7845

Pulleys are manufactured in steel.

BALANCING

UNI 4218 – ISO 1940

Pulleys prepared for a tapered bush are statically balanced within grade G.6.3.

It is possible to perform dynamic balancing, on request.

Dynamic balancing is essential for speeds exceeding 30 m/s.



DESIGN POWER CALCULATION

Make a note of the nominal power to be transmitted **P** (kw) (normally the nominal power of the electric motor), select the service factor **Co** based on the table and calculate the design power output **Pc** (kw) as follows: **Pc = Co x P**

Service factor (Co)

MOTOR TYPE

CLASS A

- Synchronous and asynchronous, squirrel cage, normal torque, alternating current motor.
- Shunt winding direct current motor
- Internal combustion engine (steady-state condition ³ 700 r.p.m.)
- Turbines

CLASS B

- Asynchronous, squirrel cage, high torque alternating current motor
- Compound winding direct current motor
- Internal combustion engine (steady-state condition ³ 700 r.p.m.)
- Clutches

TYPE OF MACHINE DRIVEN	Class A Motor			Class B Motor		
	Number of daily operating hours					
	<10	10÷16	>16	<10	<10÷16	>16
• Liquid mixers • Blowers • Extractors • Centrifuge fans • Lightweight conveyors	1	1.1	1.2	1.1	1.2	1.3
• Mixers designed for pasty products • Blenders • Generators • Laundry machines • Machine tools	1.1	1.2	1.3	1.2	1.3	1.4
• Rotary compressors • Rotary pumps • Sieves • Heavyweight conveyors • Spraying systems • Dynamo • Bakery machines • Printing machines • Wood working machines • Axial fans • Brick making machines	1.2	1.3	1.4	1.3	1.4	1.5
• Piston compressors • Piston pumps • Crushers • Bucket elevators • Elevators • Paper making machines • Mills • Hoists	1.4	1.5	1.6	1.5	1.6	1.8
• Grinding machines • Crushing machines • Drainage systems • Calenders and extruders for rubber and plastics	1.6	1.7	1.8	1.7	1.8	2

CROSS-SECTION SELECTION

R.p.m. of smallest pulley The type of cross-section is selected by using the diagram shown below.

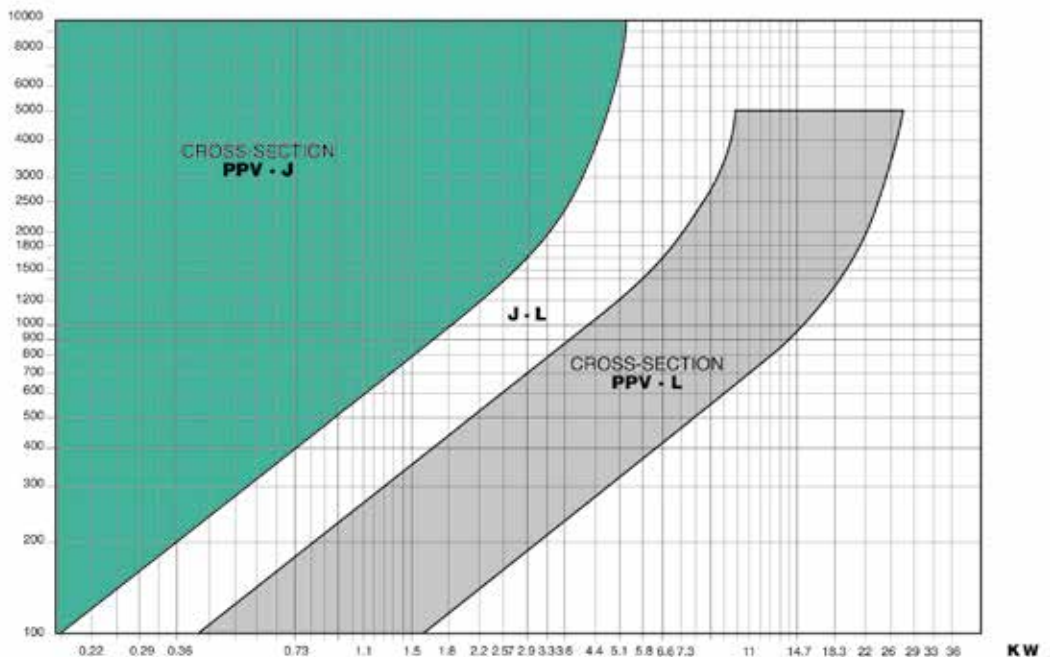



PPV-J TYPE

pitch $2,34 \pm 0,025$

N° GROOVES	F±0.1	P
8	23	3.31
12	32.5	3.38
16	42	3.45

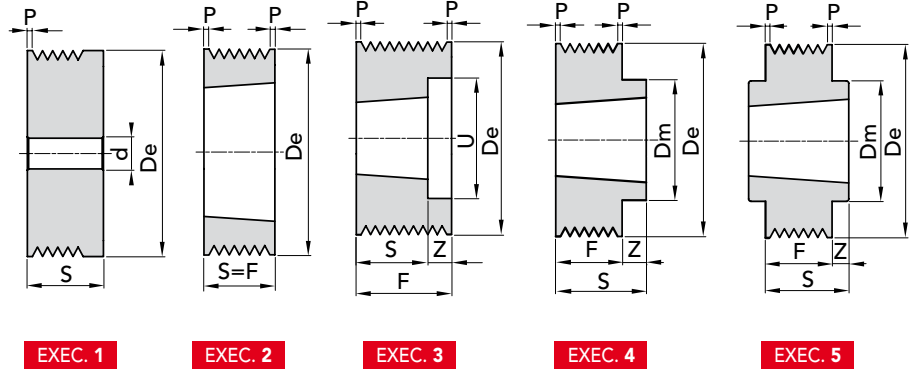

De	P. NUMBER	EXEC.	N° GROOVES	BUSHE	S	Z	Dm	U	d	WEIGHT Kg.
40	48108040	1	8	-	32	-	-	-	12	0,24
	48112040	1	12	-	41,5	-	-	-	12	0,31
	48116040	1	16	-	51	-	-	-	12	0,38
45	48108045	1	8	-	32	-	-	-	12	0,32
	48112045	1	12	-	41,5	-	-	-	12	0,41
	48116045	1	16	-	51	-	-	-	12	0,50
50	48108050	1	8	-	32	-	-	-	12	0,40
	48112050	1	12	-	41,5	-	-	-	12	0,52
	48116050	1	16	-	51	-	-	-	12	0,63
56	48108056	2	8	1108	23	-	-	-	-	0,39
	48112056	3	12	1108	23	9,5	-	40	-	0,65
	48116056	1	16	-	51	-	-	-	12	0,81
63	48108063	2	8	1108	23	-	-	-	-	0,50
	48112063	3	12	1108	23	9,5	-	46	-	0,39
	48116063	1	16	-	51	-	-	-	12	1,05
71	48108071	2	8	1108	23	-	-	-	-	0,64
	48112071	3	12	1108	23	9,5	-	46	-	0,57
	48116071	2	16	1215	42	-	-	55	-	0,63
75	48108075	2	8	1108	23	-	-	-	-	0,72
	48112075	3	12	1610	26	6,5	-	60	-	0,38
	48116075	3	16	1610	26	16	-	60	-	0,46
80	48108080	4	8	1610	26	3	70	-	-	0,41
	48112080	3	12	1610	26	6,5	-	60	-	0,52
	48116080	3	16	1610	26	16	-	60	-	0,64
85	48108085	4	8	1610	26	3	70	-	-	0,51
	48112085	3	12	1610	26	6,5	-	60	-	0,66
	48116085	3	16	1610	26	16	-	60	-	0,84
90	48108090	4	8	1610	26	3	70	-	-	0,62
	48112090	3	12	1610	26	6,5	-	74	-	0,76
	48116090	3	16	1610	26	16	-	74	-	0,87
95	48108095	4	8	1610	26	3	82	-	-	0,78
	48112095	3	12	1610	26	6,5	-	74	-	0,93
	48116095	3	16	1610	26	16	-	74	-	1,08
100	48108100	4	8	1610	26	3	82	-	-	0,90
	48112100	3	12	1610	26	6,5	-	74	-	1,10
	48116100	3	16	1610	26	16	-	74	-	1,32

De	P. NUMBER	EXEC.	N° GROOVES	BUSHE	S	Z	Dm	U	d	WEIGHT Kg.
106	48108106	4	8	1610	26	3	82	-	-	1,05
	48112106	3	12	1610	26	6,5	-	88	-	1,24
	48116106	3	16	1610	26	16	-	88	-	1,40
112	48108112	4	8	1610	26	3	90	-	-	1,25
	48112112	3	12	1610	26	6,5	-	88	-	1,47
	48116112	3	16	1610	26	16	-	88	-	1,70
118	48108118	4	8	1610	26	3	90	-	-	1,43
	48112118	3	12	2012	32	0,5	-	98	-	1,55
	48116118	3	16	2012	32	10	-	98	-	1,79
125	48108125	4	8	1610	26	3	90	-	-	1,64
	48112125	3	12	2012	32	0,5	-	98	-	1,90
	48116125	3	16	2012	32	10	-	98	-	2,18
132	48108132	4	8	1610	26	3	90	-	-	1,88
	48112132	3	12	2012	32	0,5	-	98	-	2,21
	48116132	3	16	2012	32	10	-	98	-	2,60
140	48108140	4	8	1610	26	3	90	-	-	1,60
	48112140	4	12	2517	45	12,5	120	-	-	7,10
	48116140	4	16	2517	45	3	120	-	-	9,60
160	48108160	5	8	2012	32	4,5	110	-	-	3,01
	48112160	4	12	2517	45	12,5	120	-	-	3,80
	48116160	4	16	2517	45	3	120	-	-	4,37
180	48108180	5	8	2012	32	4,5	110	-	-	3,92
	48112180	5	12	2517	45	6,25	120	-	-	5,03
	48116180	5	16	2517	45	1,5	120	-	-	5,97
200	48108200	5	8	2012	32	4,5	110	-	-	4,88
	48112200	5	12	2517	45	6,25	120	-	-	6,40
	48116200	5	16	2517	45	1,5	120	-	-	7,75
224	48108224	5	8	2012	32	4,5	110	-	-	6,17
	48112224	5	12	2517	45	6,25	120	-	-	8,29
	48116224	5	16	2517	45	1,5	120	-	-	10,10
250	48108250	5	8	2012	32	4,5	110	-	-	7,73
	48112250	5	12	2517	45	6,25	120	-	-	7,95
	48116250	5	16	2517	45	1,5	120	-	-	8,20

V-BELT PULLEYS PPV-J MICRO V DIMENSIONS



PPV-L TYPE

pitch $4,70 \pm 0,050$

N° GROOVES **F±0.1**

8	48	7.55
12	67	7.65
16	86	7.75

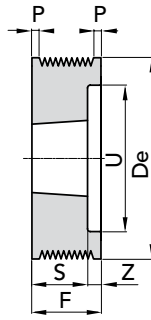

EXEC. 3

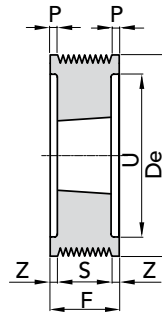

EXEC. 6

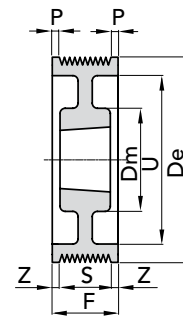

EXEC. 7

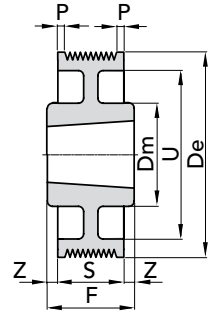

EXEC. 8

De	P. NUMBER	EXEC.	N° GROOVES	BUSHE	S	Z	Dm	U	WEIGHT Kg.	De	P. NUMBER	EXEC.	N° GROOVES	BUSHE	S	Z	Dm	U	WEIGHT Kg.
75	48208075	3	8	1210	26	22	-	56	0,66	140	48208140	3	8	2517	45	3	82	116	3,02
	48212075	3	12	1215	42	25	-	56	0,97		48212140	6	12	2517	45	11	-	116	3,55
80	48208080	3	8	1210	26	22	-	56	0,86	150	48212150	6	12	2517	45	11	-	126	4,30
	48212080	3	12	1215	42	25	-	56	1,25		48216150	6	16	2517	45	20,5	-	126	4,85
85	48208085	3	8	1210	26	22	-	61	1,00	160	48208160	3	8	2517	45	3	-	136	4,54
	48212085	3	12	1215	42	25	-	61	1,47		48212160	6	12	2517	45	11	-	136	5,12
	48216085	6	16	1215	42	22	-	61	1,76		48216160	6	16	3020	52	17	-	136	4,88
90	48208090	3	8	1610	26	22	-	66	1,01	170	48208170	3	8	2517	45	3	-	146	5,35
	48212090	3	12	1615	42	25	-	66	1,45		48212170	6	12	2517	45	11	-	146	6,03
	48216090	6	16	1615	42	22	-	66	1,78		48216170	6	16	3020	52	17	-	146	5,96
95	48208095	3	8	1610	26	22	-	71	1,16	180	48208180	7	8	2517	45	1,5	120	156	4,52
	48212095	3	12	1615	42	25	-	71	1,71		48212180	7	12	2517	45	11	120	156	5,34
	48216095	6	16	1615	42	22	-	71	2,02		48216180	6	16	3020	52	17	-	156	7,09
100	48208100	3	8	1610	26	22	-	76	1,31	200	48208200	7	8	2517	45	1,5	120	176	5,07
	48212100	3	12	2012	32	35	-	79	1,39		48212200	7	12	3020	52	7,5	146	176	6,99
	48216100	6	16	2012	32	27	-	79	1,69		48216200	7	16	3020	52	17	146	176	7,92
106	48208106	3	8	1610	26	22	-	82	1,53	224	48208224	7	8	2517	45	1,5	120	202	9,77
	48212106	3	12	2012	32	35	-	82	1,76		48212224	7	12	3020	52	7,5	146	202	11,0
	48216106	6	16	2012	32	27	-	82	2,12		48216224	7	16	3020	52	17	146	202	14,12
112	48208112	3	8	1610	26	22	-	88	1,75	250	48208250	8	8	3020	52	2	146	228	13,12
	48212112	3	12	2012	32	35	-	88	2,02		48212250	7	12	3020	52	7,5	146	228	15,60
	48216112	6	16	2012	32	27	-	88	2,42		48216250	8	16	3535	89	1,5	178	228	16,13
118	48208118	3	8	2012	32	16	-	94	1,88	280	48208280	8	8	3020	52	2	146	256	18,18
	48212118	6	12	2517	45	11	-	97	1,96		48212280	7	12	3020	52	7,5	146	256	21,75
	48216118	6	16	2517	45	20,5	-	97	2,31		48216280	8	16	3535	89	1,5	178	256	24,45
125	48208125	3	8	2012	32	16	-	101	2,22	315	48208315	8	8	3020	52	2	146	285	24,82
	48212125	6	12	2517	45	11	-	101	2,46		48212315	8	12	3535	89	11	178	285	42,64
	48216125	6	16	2517	45	20,5	-	101	2,92		48216315	8	16	3535	89	1,5	178	285	35,34
132	48208132	3	8	2012	32	16	-	108	2,54										
	48212132	6	12	2517	45	11	-	108	2,97										
	48216132	6	16	2517	45	20,5	-	108	3,44										