

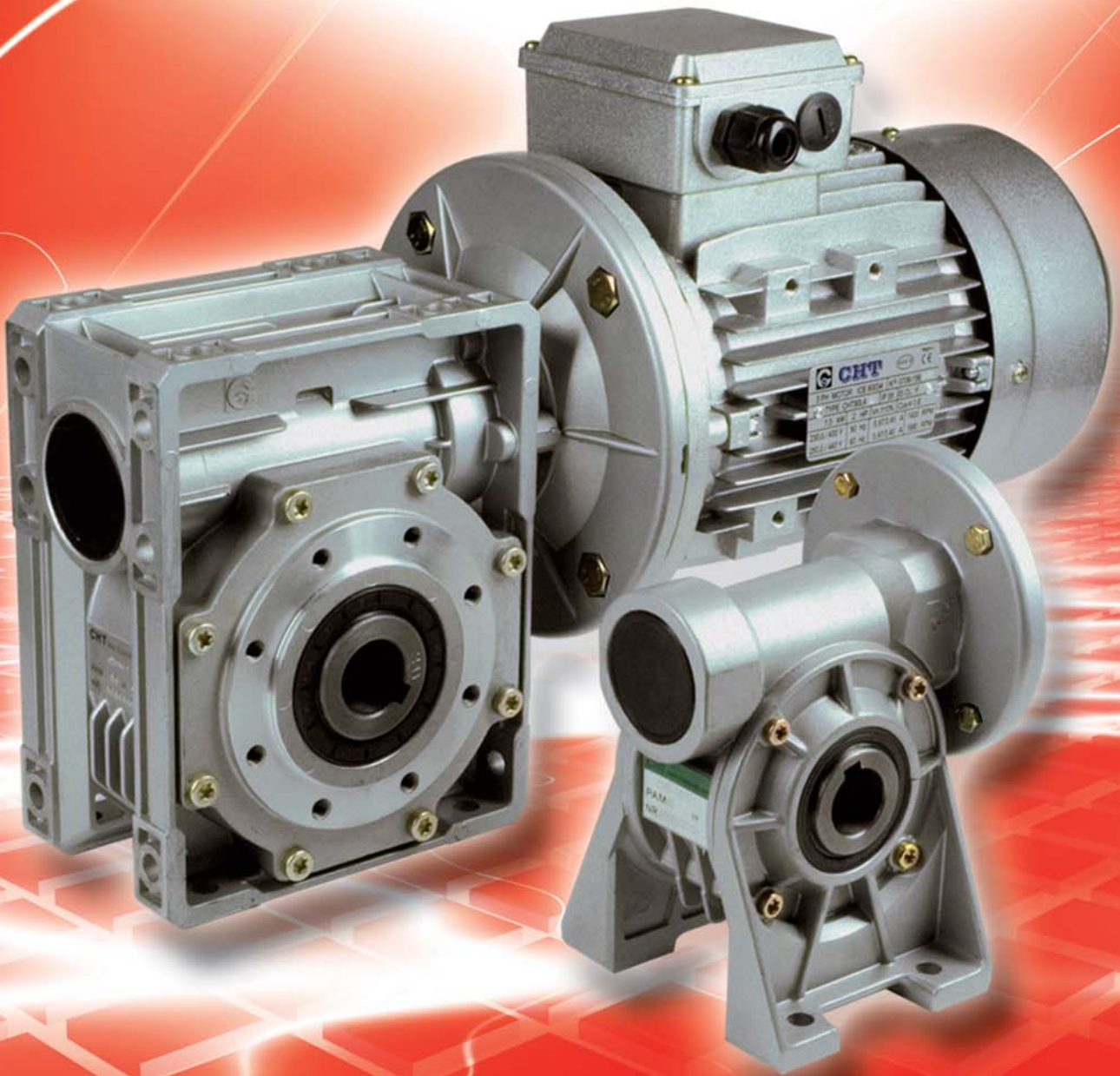

**CHIARAVALLI**  
S.p.A



**MOTORIDUTTORI E RIDUTTORI  
A VITE SENZA FINE CHB**

**CHB WORM GEARED MOTORS  
AND WORM GEAR UNITS**

## PREMESSA - INTRODUCTION

Il nuovi riduttori a vite senza fine serie CHB della Chiaravalli S.p.A. nascono per venire incontro alle esigenze di parte del mercato che richiede un prodotto di forma costruttiva e dimensionale che permetta di non modificare disegni già esistenti e garantire continuità nei ricambi. Nell'affrontare questo nuovo prodotto Chiaravalli ha voluto comunque apportare quegli aggiornamenti tecnici che garantiscono maggiore facilità nell'adattare i gruppi alle varie configurazioni di montaggio, con la conseguenza di poter offrire un servizio migliore in termini di versatilità e consegna.

Dalle considerazioni sopra espresse nasce quindi un riduttore con flangia attacco motore scindibile dalla cassa la quale però incorpora l'anello di tenuta, in questo modo la sostituzione della flangia di ingresso non comporta alcun rischio di danneggiamento dell'anello stesso, permettendo inoltre l'eliminazione dell'O-ring. Tutti i coperchi laterali, sia pendolari che con piedi, montano O-ring al posto delle tradizionali guarnizioni piane, in questo modo, nelle grandezze 03-04-05, la rotazione dei piedi avviene senza alcuno smontaggio degli stessi, inoltre le versioni dotate di coperchi laterali permettono l'alloggiamento delle flange laterali da ambo le parti tramite semplici viti di fissaggio. La vite senza fine presenta un profilo ad evolvente ZI, con questo accoppiamento vite-corona si ottiene un rendimento maggiore ed una conseguente riduzione della temperatura. Come da tradizione Chiaravalli i riduttori, come del resto anche i motori, sono verniciati con polveri epossidiche color alluminio RAL 9022 per proteggere le parti dall'ossidazione e per ottenere una migliore protezione delle microsoffiature che possono essere presenti nelle pressofusioni. Le precoppie CHPC già presenti sul catalogo CHM, possono essere montate anche su questa serie, permettendo così di ottenere rapporti di riduzione fino a 1:300, inoltre per maggiori riduzioni è possibile la combinazione di due riduttori tramite un kit predisposto.

*The new CHB worm gearboxes of Chiaravalli SPA have been produced to satisfy the market that require a product in dimensions and construction without changing the existing drawings and to guarantee non stop of their spare parts.*

*Chiaravalli designed this new product by improving and introducing better technical modifications to offer easier application of the groups to the different assembling configurations so that by offering a better service in flexibility and delivery time.*

*Starting from these considerations, we have a gearbox with a motor mounting flange that is separable from the housing which incorporate the oil seal; in this way we avoid any risk of damaging the oil seal in case of replacement of the input flange and the O-Ring can be eliminated.*

*All the aside covers, swinging and with feet, have O-Rings instead of traditional flat gaskets. The sizes 03-04-05 allow the rotation of the feet without disassembling them; furthermore the versions with swinging aside covers allow the lateral flanges to be fitted on both sides with simple fixing screws.*

*The worm screw has a ZI involute profile: with this worm-wheel coupling we shall get a better performance with a temperature reduction. The gearboxes and motors are painted with RAL 9022 aluminium colour epoxy powder to protect the parts from oxidation and against micro-blowholes that can come during the pressure of die-castings.*

*The CHPC pre-stage gears (already present in the catalogue of CHM) can also be mounted with this range, obtaining a gear ratio up to 1:300. For bigger reductions is possible to have two gears together using an appropriate kit.*

## LUBRIFICAZIONE

Tutti i gruppi vengono forniti completi di lubrificante sintetico, sono pertanto esenti da manutenzione e possono essere montati in qualsiasi posizione, i tipi di lubrificante sono descritti nella tabella sottostante.

Lubrificante	Ambiente	ISO	AGIP	SHELL	IP
°C ambiente	-25°C/+50°C	VG 320	Telium VSF 320	Tivela oil S 320	Telium VSF

## LUBRICATION

*All of the groups are supplied with a synthetic lubricant maintenance free and can be mounted in any position. The types of lubricants are described in the table here below.*

Lubricant	Ambient	ISO	AGIP	SHELL	IP
°C ambient	-25°C/+50°C	VG 320	Telium VSF 320	Tivela oil S 320	Telium VSF



## QUANTITA' OLIO LITRI - QUANTITY OF OIL IN LITRES

CHB	03	04	05	06	07	08
	0.035	0.055	0.090	0.38	0.52	0.73

## PREDISPOSIZIONE ATTACCO MOTORE

I riduttori che vengono forniti con predisposizione attacco motore devono essere accoppiati a motori che abbiano tolleranze di albero e flangia corrispondenti ad una qualità di classe "normale" onde evitare vibrazioni e forzature del cuscinetto in entrata, i motori forniti da Chiaravalli garantiscono la rispondenza a queste esigenze.

Nella tabella seguente viene messa in corrispondenza la grandezza del motore B5 e B14 con le dimensioni dell'albero e della flangia attacco motore onde agevolare la consultazione. Si ricorda che, essendo le flange attacco motore scindibili dalla cassa è sempre possibile la combinazione di alberi e flange non corrispondenti alla tabella es. 19/140, questa soluzione permette di adattarsi anche ai motori non unificati es. brushless o corrente continua.

PAM	056	063	071	080	090	100	112
<b>B5</b>	9/120	11/140	14/160	19/200	24/200	28/250	28/250
<b>B14</b>	9/80	11/90	14/105	19/120	24/140	28/160	28/160

## MOTOR MOUNTING FLANGES

Gears supplied with mounting flanges must be assembled with motors whose shaft and flange tolerances correspond to a "normal" class of quality in order to avoid vibration and forcing of the input bearing. Motors supplied by Chiaravalli guarantee this requirement fulfilled. For ease of consultation, the correspondence of the size of the B5 and B14 motor with the sizes of the shaft and the motor connection flange are shown in the following table.

Remember that, as the motor connection flanges are separate from the body it is also possible to have a shaft / flange combination that does not correspond to the table, e.g. 19/140, thereby offering adaptability for other non-unified models such as the brushless or direct current types.

MMF	056	063	071	080	090	100	112
<b>B5</b>	9/120	11/140	14/160	19/200	24/200	28/250	28/250
<b>B14</b>	9/80	11/90	14/105	19/120	24/140	28/160	28/160

## ROTAZIONE PIEDI - FEET ROTATION

I riduttori con piedi possono essere ruotati nelle posizioni N e V semplicemente svitando le viti di fissaggio, l'unico accorgimento da adottare è quello di applicare sulle 4 viti in corrispondenza della vite senza fine, del sigillante, in quanto i fori sono passanti.

Gears with feet can be rotated into the N and V positions by simply unscrewing the fixing screws. We recommend that some sealant is applied to the 4 screws close to the worm screw, as the holes are through holes.



CHB...



CHB...P



CHBE...



CHBE...P



CHBR...



CHBR...P



CHBRE...



CHBRE...P



TIPO (1)	GRANDEZZA	VERSIONE	POS. FLANGIA (2)	i	P.A.M.	POS.MONT
TYPE (1)	SIZE	VERSION	FLANGE POS. (2)	i	M.M.F.	MOUNT. POS.
CHB	03	PF	1	Rapporto di riduzione vedi pag. 56 Ratio see page 56	63B5	UNIVERSALE
CHB..P		N	2		63B14	
CHBR		V			56B5	
CHBR..P					56B14	
CHBE						
CHBE..P						
CHBRE						
CHBRE..P						

TIPO (1)	GRANDEZZA	VERSIONE	POS. FLANGIA (2)	i	P.A.M.	POS.MONT
TYPE (1)	SIZE	VERSION	FLANGE POS. (2)	i	M.M.F.	MOUNT. POS.
CHB	04	PF	1	Rapporto di riduzione vedi pag. 57 Ratio see page 57	71B5	UNIVERSALE
CHB..P		PFA	2		71B14	
CHBR		N			63B5	
CHBR..P		V			63B14	
CHBE						
CHBE..P						
CHBRE						
CHBRE..P						

TIPO (1)	GRANDEZZA	VERSIONE	POS. FLANGIA (2)	i	P.A.M.	POS.MONT
TYPE (1)	SIZE	VERSION	FLANGE POS. (2)	i	M.M.F.	MOUNT. POS.
CHB	05	PF	1	Rapporto di riduzione vedi pag. 58 Ratio see page 58	80B5	UNIVERSALE
CHB..P		PFA	2		80B14	
CHBR		N			71B5	
CHBR..P		V			71B14	
CHBE					63B5	
CHBE..P					63B14	
CHBRE						
CHBRE..P						

## ESEMPIO ORDINE - EXAMPLE ORDER

CHB	04P	FA	2	35	63 B14
CHB	04			10	71 B5

Nel caso venga richiesto anche il motore specificare:

*If the motor is also required, please specify:*

Grandezza - Size es. 63 C4  
 Potenza - Power es. Kw 0.22  
 Poli - Poles es. 4  
 Tensione - Voltage es. V230/400  
 Frequenza - Frequency es. 50 Hz  
 Flangia - Flange es. B 14

N.B. Quando il riduttore è richiesto con flangia uscita F o FA deve essere ordinato versione PF o PFA.

*N.B. Gear box required with output flanges F or FA must be ordered PF or PFA version.*

1) vedi pagina 53 - see page 53

2) vedi pagina 55 - see page 55

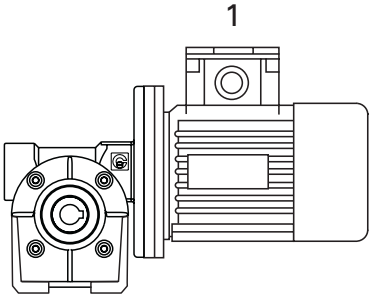
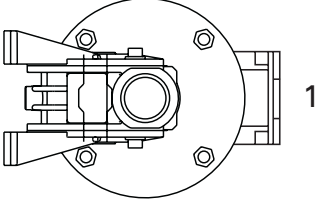
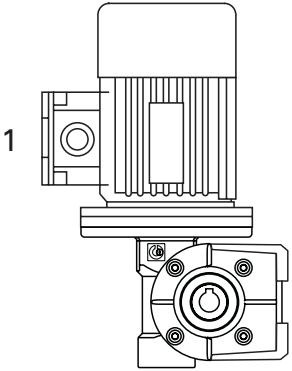
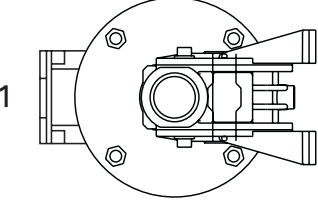
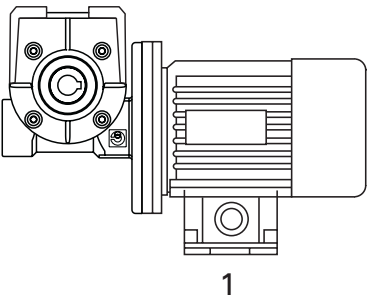
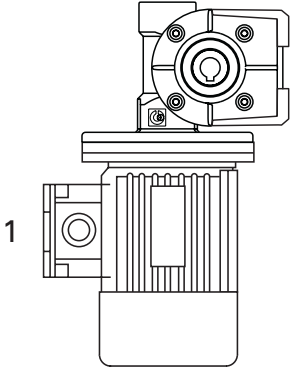
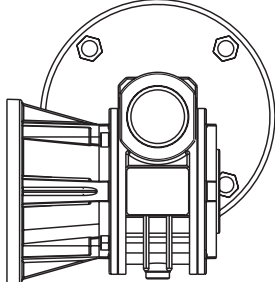
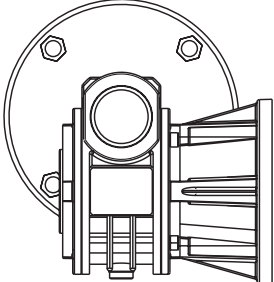
<p><b>B3</b></p> 	<p><b>B6</b></p> 	<p><b>V5</b></p> 	
<p><b>B7</b></p> 	<p><b>B8</b></p> 	<p><b>V6</b></p> 	
<p><b>PF1</b></p> 		<p><b>PF2</b></p> 	

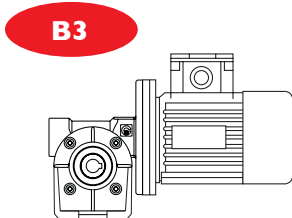
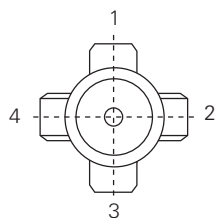

**POSIZIONE MORSETTERIA**

N.B. La posizione della morsetteria si riferisce sempre alla pos. B3

**TERMINAL BOX POSITION**

N.B. The position of the terminal box always refers to the B3 position.



# CHB 03

## PRESTAZIONI CON MOTORI A 4 POLI - 1400 GIRI ENTRATA PERFORMANCE WITH 4-POLE MOTORS - 1400 REVS. INPUT

TIPO	i=ratio	n2 r/min	Kw=P1	Nm=T2	f.s.	Pred. attacco motore possibili	
TYPE	i=ratio	n2 r/min	Kw=P1	Nm=T2	f.s.	Possible types of motor connections	
	7	200	0.22	8	1.8	63/56	B5/B14
	10	140	0.22	11	1.4	63/56	B5/B14
	15	93	0.22	16	1.0	63/56	B5/B14
<b>CHB 03</b>	20	70	0.22	20	0.9	63/56	B5/B14
	30	47	0.18	22	0.8	63/56	B5/B14
	40	35	0.12	18	1.0	63/56	B5/B14
	60	23	0.09	18	1.0	63/56	B5/B14
	70	20	0.09	15	0.9	56	B5/B14

Peso Kg 1  
Weight Kg 1

### CHB 03 DIMENSIONI - DIMENSIONS

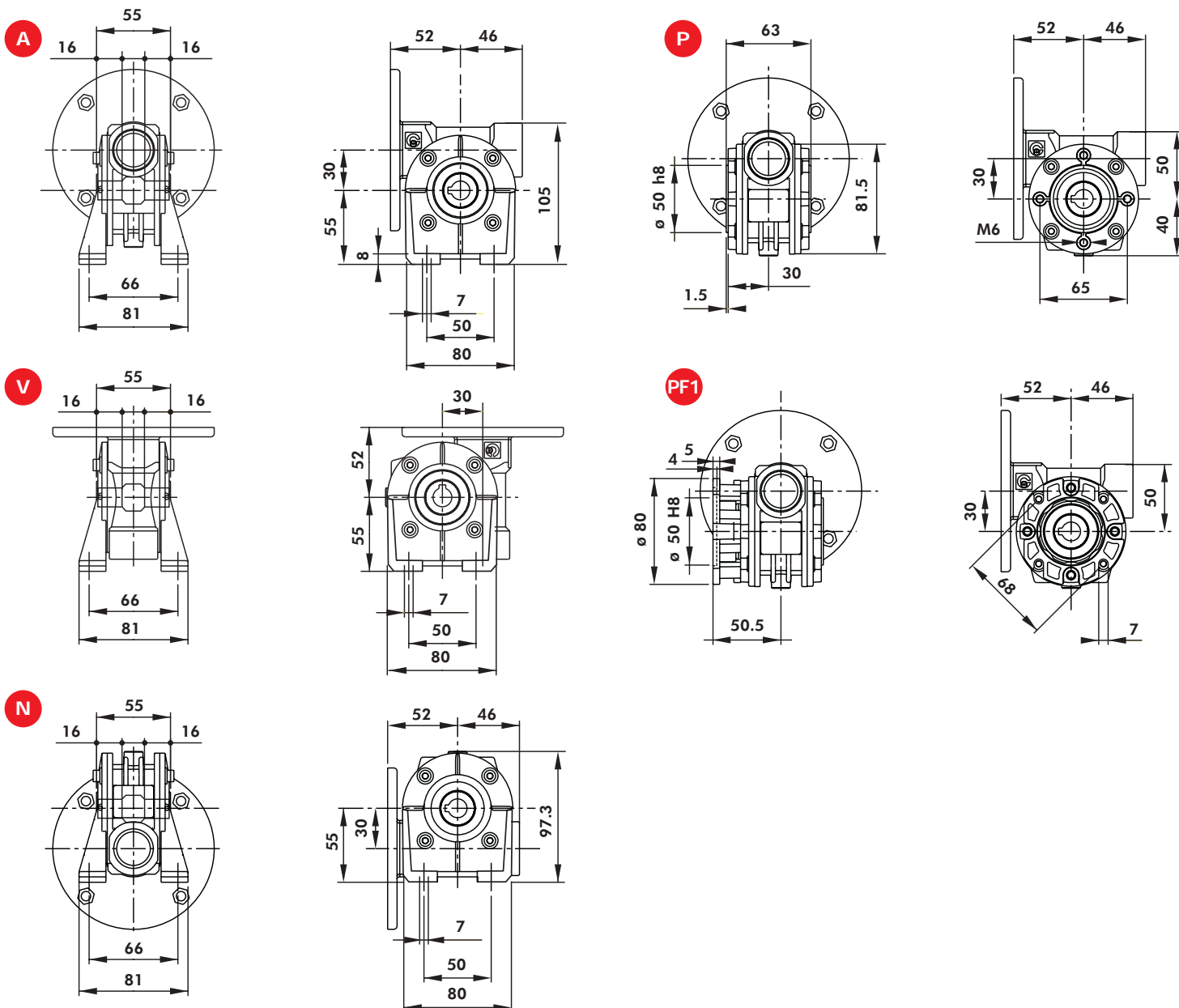

# CHB 04

**PRESTAZIONI CON MOTORI A 4 POLI - 1400 GIRI ENTRATA**  
**PERFORMANCE WITH 4-POLE MOTORS - 1400 REVS. INPUT**

TIPO	i=ratio	n2 r/min	Kw=P1	Nm=T2	f.s.	Pred. attacco motore possibili	
TYPE	i=ratio	n2 r/min	Kw=P1	Nm=T2	f.s.	Possible types of motor connections	
CHB 04	7	200	0.55*	22	1.4	71/63	B5/B14
	10	140	0.55*	30	1.0	71/63	B5/B14
	14	100	0.37	29	1.0	71/63	B5/B14
	20	70	0.37	38	1.0	71/63	B5/B14
	28	50	0.37	40	0.9	71/63	B5/B14
	35	40	0.25	41	0.9	71/63	B5/B14
	46	30	0.18	37	1.0	63	B5/B14
	60	23	0.18	37	0.9	63	B5/B14
	70	20	0.12	33	0.9	63	B5/B14
	100	14	0.12	30	0.9	63	B5/B14

\* Motori gr.71 - \* Motors 71 gr.

Peso Kg 2,1  
Weight Kg 2,1

## CHB 04 DIMENSIONI - DIMENSIONS

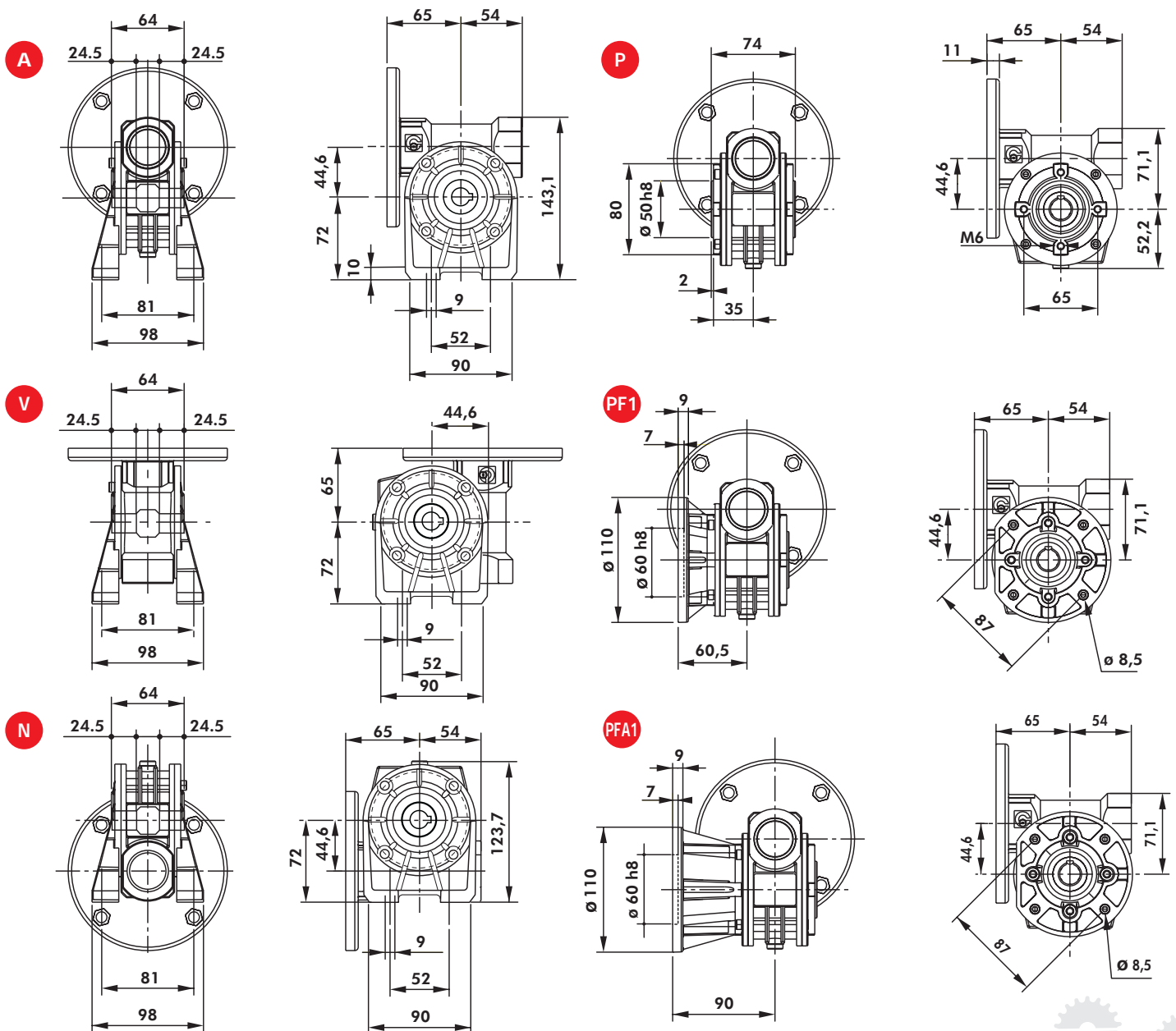



# CHB 05

## PRESTAZIONI CON MOTORI A 4 POLI - 1400 GIRI ENTRATA PERFORMANCE WITH 4-POLE MOTORS - 1400 REVS. INPUT

TIPO	i=ratio	n2 r/min	Kw=P1	Nm=T2	f.s.	Pred. attacco motore possibili	
TYPE	i=ratio	n2 r/min	Kw=P1	Nm=T2	f.s.	Possible types of motor connections	
	7	200	1.1*	40	1.4	80/71	B5/B14
	10	140	1.1*	49	1.2	80/71	B5/B14
	14	100	0.75	57	1.1	80/71	B5/B14
	18	78	0.55	52	1.1	80/71	B5/B14
	24	58	0.55	67	0.9	80/71	B5/B14
	28	50	0.55	73	1.0	80/71	B5/B14
	36	39	0.37	61	1.1	71	B5/B14
	45	31	0.37	65	0.9	71	B5/B14
	60	23	0.25	60	1.0	71/63	B5/B14
	70	20	0.22	55	0.9	63	B5/B14
	80	17	0.18	54	1.0	63	B5/B14
	100	14	0.18	50	0.9	63	B5/B14

CHB 05

\* Motori gr.80 - \* Motors 80 gr.

Peso Kg 3  
Weight Kg 3

### CHB 05 DIMENSIONI - DIMENSIONS

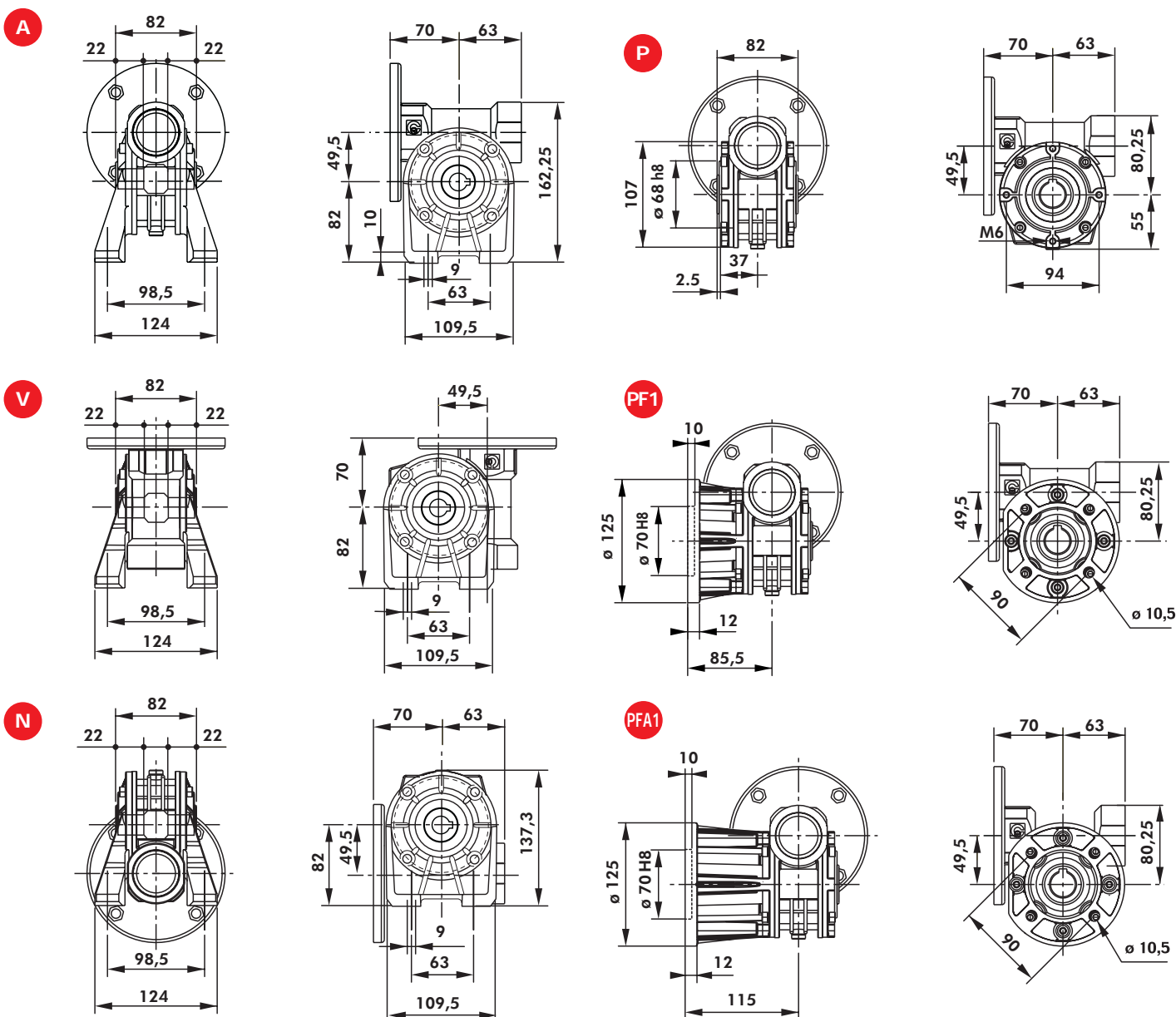

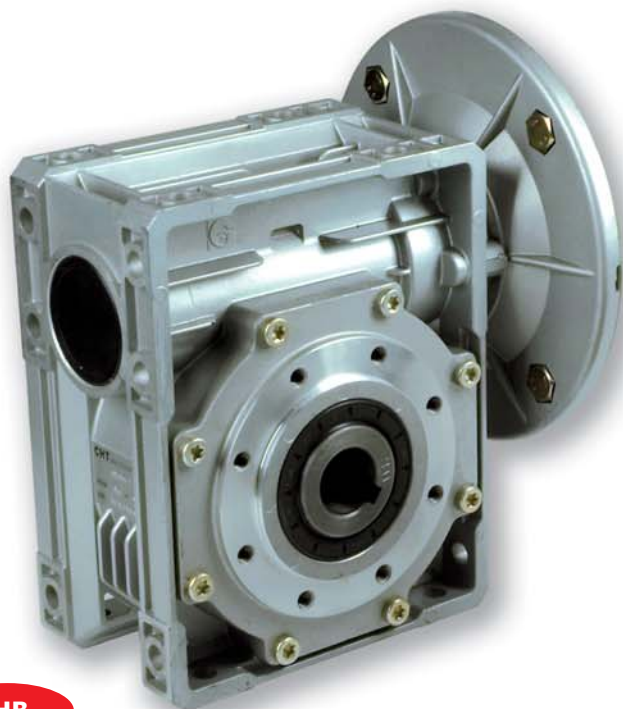

CHB..

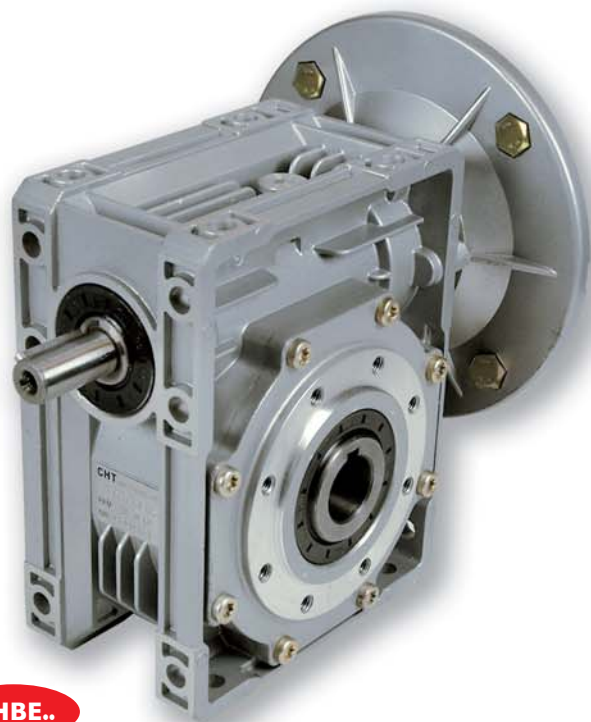

CHBE..



CHBR..

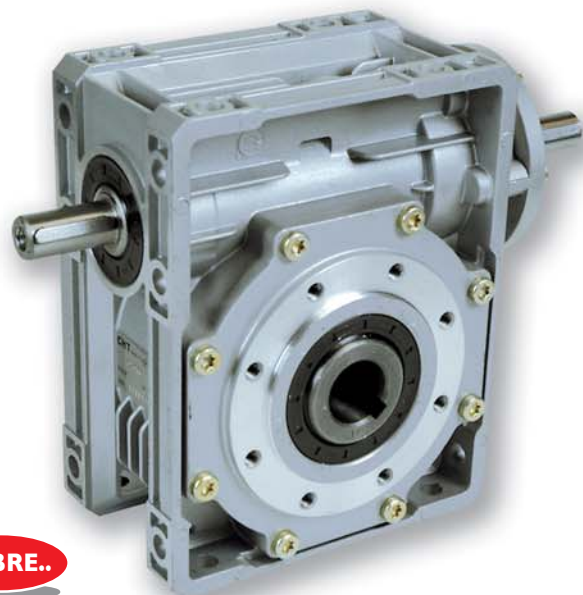

CHBRE..



**CHB 06/07/08****DESIGNAZIONE - DESIGNATION**

TIPO (1)	GRANDEZZA	VERSIONE	POS. FLANGIA (2)	i	P.A.M.	POS.MONT
TYPE (1)	SIZE	VERSION	FLANGE POS. (2)	i	M.M.F.	MOUNT. POS.
CHB	06	FC	1	Rapporto di riduzione vedi pag. 62-63-64 Ratio see page 62 63-64	100B5	UNIVERSALE
CHBR	07	F	2		100B14	
CHBE	08	(3)			90B5	
CHBRE					90B14	
					80B5	
					80B14	
					71B5	
					71B14	

**ESEMPIO ORDINE - EXAMPLE ORDER**

<b>CHB</b>	<b>06</b>	<b>FC</b>	<b>1</b>	<b>19</b>	<b>90 B5</b>
------------	-----------	-----------	----------	-----------	--------------

Nel caso venga richiesto anche il motore specificare:

*If the motor is also required, please specify:*

Grandezza - Size es. 90 L4  
 Potenza - Power es. Kw 1.5  
 Poli - Poles es. 4  
 Tensione - Voltage es. V230/400  
 Frequenza - Frequency es. 50 Hz  
 Flangia - Flange es. B5

1) vedi pagina 59 - *see page 59*

2) vedi pagina 61 - *see page 61*

3) nessuna indicazione significa senza flangia d'uscita

*lack of instructions indicates that the gear is not equipped with an output flange*



# POSIZIONE DI MONTAGGIO - MOUNTING POSITION

**B3**

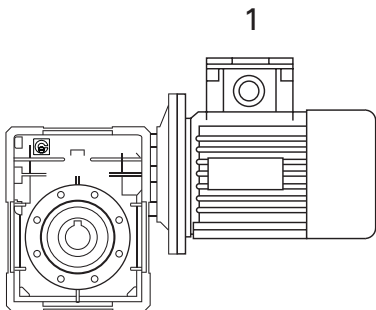

**B6**

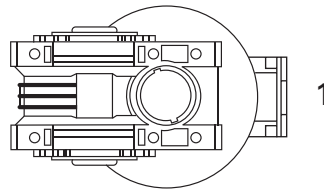

**V5**

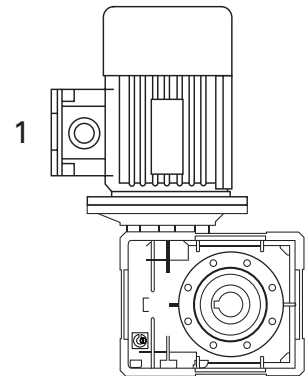

**B7**

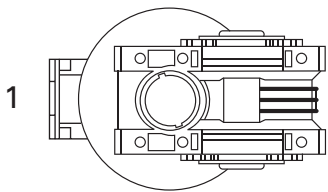

**B8**

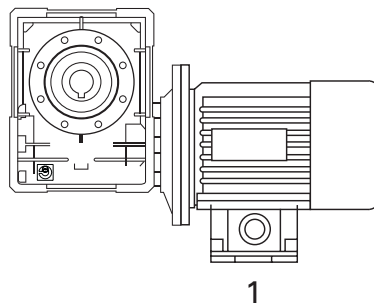

**V6**

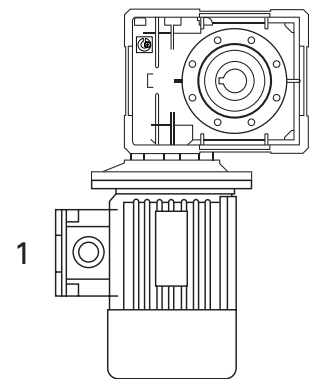

**F1**

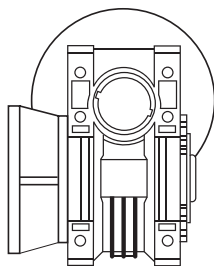

**F2**

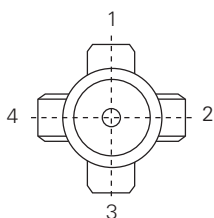
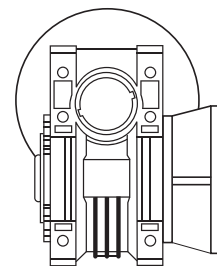

**B3**

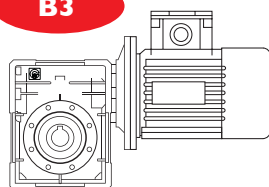

## POSIZIONE MORSETTERIA

N.B. La posizione della morsetteria si riferisce sempre alla pos. B3

## TERMINAL BOX POSITION

N.B. The position of the terminal box always refers to the B3 position.



# CHB 06

## PRESTAZIONI CON MOTORI A 4 POLI - 1400 GIRI ENTRATA PERFORMANCE WITH 4-POLE MOTORS - 1400 REVS. INPUT

TIPO	i=ratio	n2 r/min	Kw=P1	Nm=T2	f.s.	Pred. attacco motore possibili	
TYPE	i=ratio	n2 r/min	Kw=P1	Nm=T2	f.s.	Possible types of motor connections	
CHB 06	7	200	1.85	75	1.5	90/80	B5/B14
	10	140	1.85	105	1.3	90/80	B5/B14
	12	117	1.85	129	1.1	90/80	B5/B14
	15	93	1.85	146	1.0	90/80	B5/B14
	19	74	1.50	150	1.0	90/80	B5/B14
	24	58	1.10	138	1.1	90/80	B5/B14
	30	47	1.10	155	1.0	90/80	B5/B14
	38	37	0.75	133	1.1	90/80	B5/B14
	45	31	0.75	152	0.9	80/71	B5/B14
	64	22	0.37	101	1.2	80/71	B5/B14
	80	17	0.37	112	1.0	71	B5/B14
	100	14	0.37	110	1.0	71	B5/B14

Peso Kg 5,2  
Weight Kg 5,2

### CHB 06 DIMENSIONI - DIMENSIONS

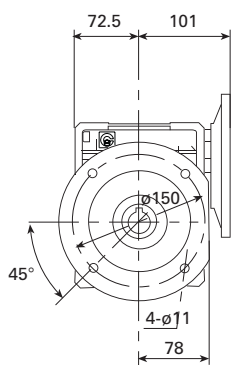
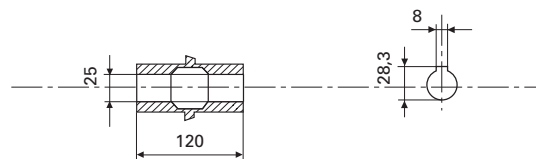
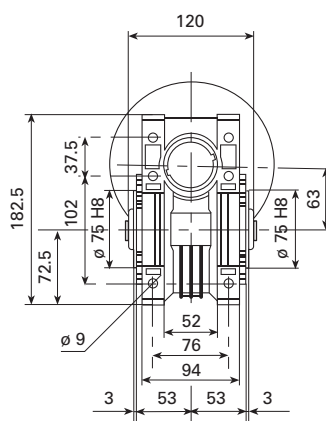
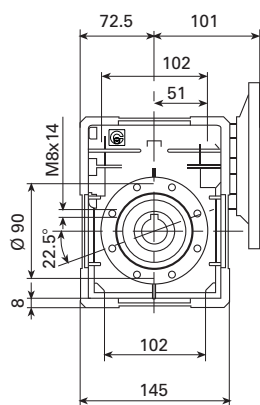

CHB06FC 1

CHB06FC 2

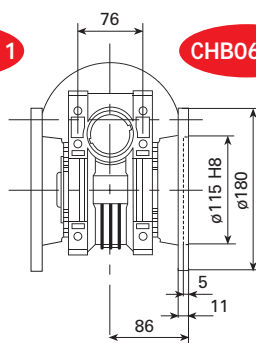

CHB06F1

CHB06F2

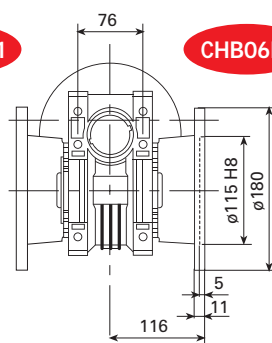

# CHB 07

## PRESTAZIONI CON MOTORI A 4 POLI - 1400 GIRI ENTRATA PERFORMANCE WITH 4-POLE MOTORS - 1400 REVS. INPUT

TIPO	i=ratio	n2 r/min	Kw=P1	Nm=T2	f.s.	Pred. attacco motore possibili	
TYPE	i=ratio	n2 r/min	Kw=P1	Nm=T2	f.s.	Possible types of motor connections	
	7	200	4	170	1.1	100/90	B5/B14
	10	140	3	175	1.3	100/90	B5/B14
	15	93	3	250	1.0	100/90	B5/B14
	20	70	2.20	240	1.0	100/90	B5/B14
<b>CHB 07</b>	25	56	1.85	250	1.0	90/80	B5/B14
	30	47	1.50	230	1.2	90/80	B5/B14
	40	35	1.1	215	1.2	90/80	B5/B14
	50	28	1.1	220	0.9	90/80	B5/B14
	60	23	0.75	200	1.0	90/80	B5/B14
	80	17	0.55	180	1.0	80/71	B5/B14 *
	100	14	0.37	140	1.1	80/71	B5/B14 *

\*71 solo - only B5

Peso Kg 9,2  
Weight Kg 9,2

### CHB 07 DIMENSIONI - DIMENSIONS

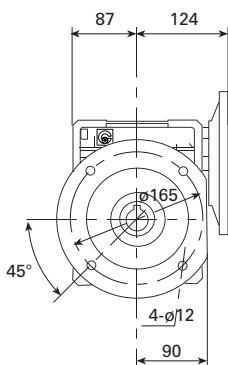
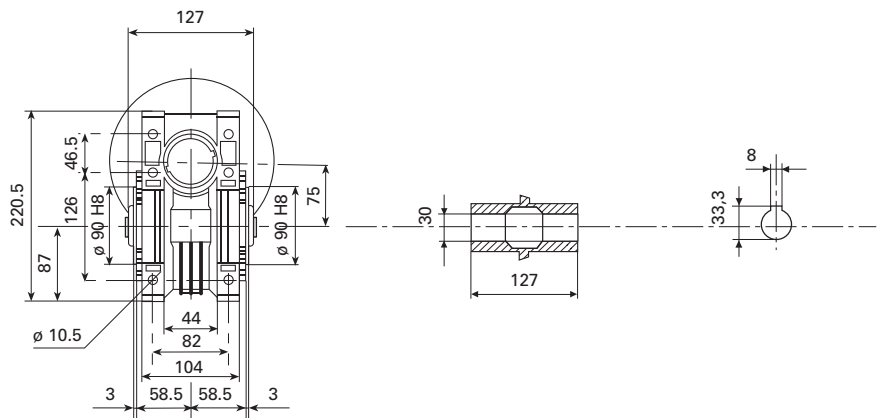
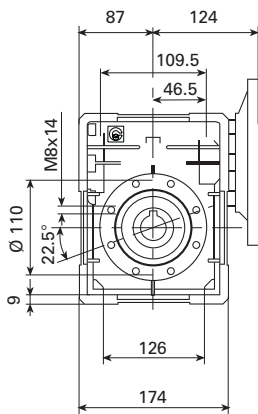

**CHB07FC 1**

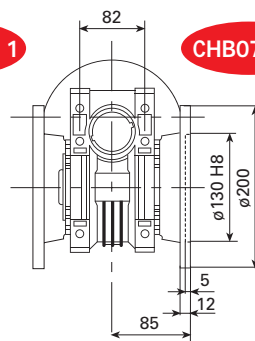

**CHB07FC 2**

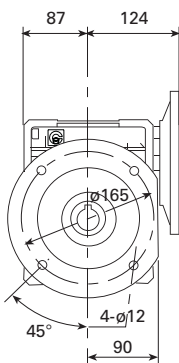

**CHB07F1**

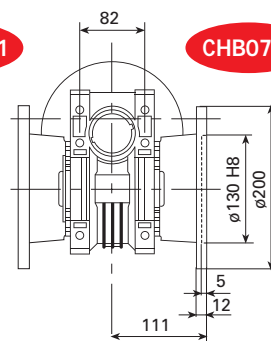

**CHB07F2**



# CHB 08

## PRESTAZIONI CON MOTORI A 4 POLI - 1400 GIRI ENTRATA PERFORMANCE WITH 4-POLE MOTORS - 1400 REVS. INPUT

TIPO	i=ratio	n2 r/min	Kw=P1	Nm=T2	f.s.	Pred. attacco motore possibili	
TYPE	i=ratio	n2 r/min	Kw=P1	Nm=T2	f.s.	Possible types of motor connections	
	7	200	4	170	1.5	112/100/90	B5/B14
	10	140	4	240	1.2	112/100/90	B5/B14
	15	93	4	350	0.9	112/100/90	B5/B14
	20	70	3.00	340	0.9	100/90	B5/B14
<b>CHB 08</b>	23	61	2.20	280	1.1	100/90	B5/B14
	30	47	2.20	340	1.1	100/90	B5/B14
	40	35	1.85	340	0.9	90/80	B5/B14
	46	30	1.5	340	1.0	90/80	B5/B14
	56	25	1.1	290	1.0	90/80	B5/B14
	64	22	1.1	290	0.9	90/80	B5/B14
	80	17	0.75	260	1.0	90/80	B5/B14
	100	14	0.55	220	1.0	80	B5/B14

Peso Kg 12,2  
Weight Kg 12,2

### CHB 08 DIMENSIONI - DIMENSIONS

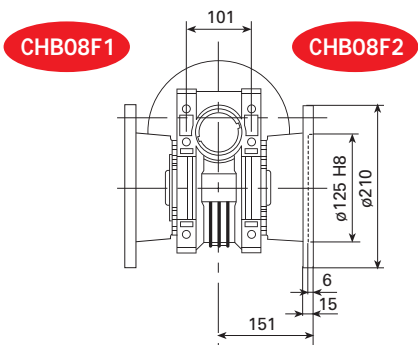
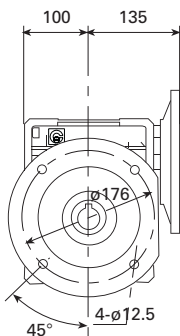
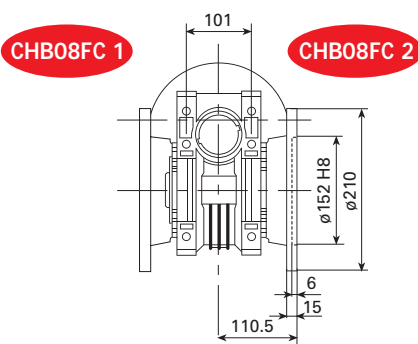
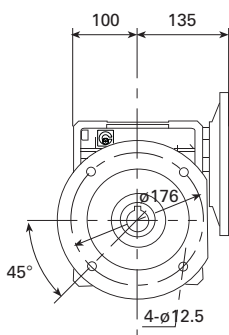
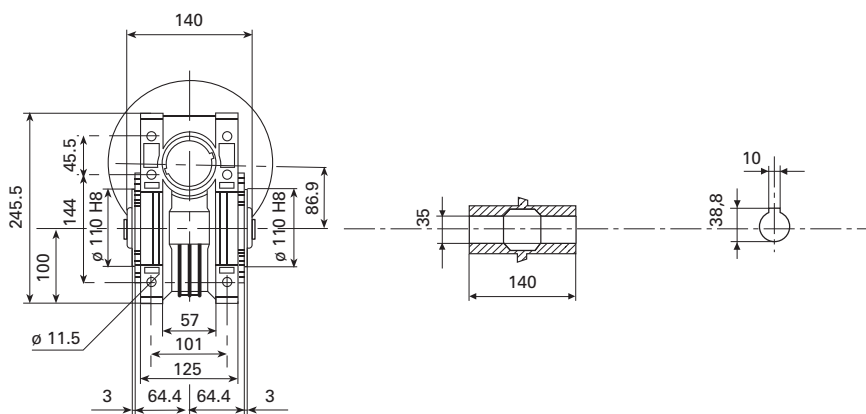
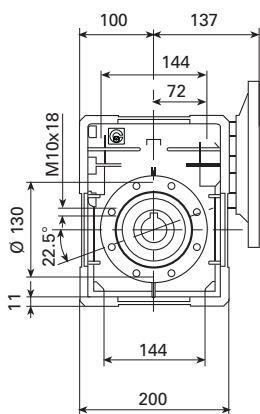

# CHBR/CHBRE DIMENSIONI - DIMENSIONS

**CHBR 03-04-05**

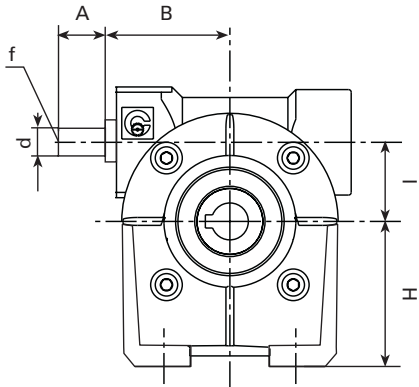

**CHBR 06-07-08**

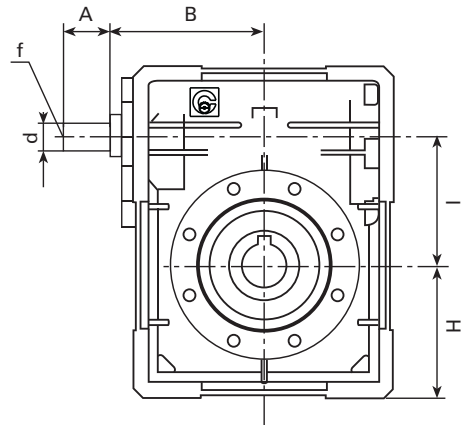

**CHBRE 03-04-05**

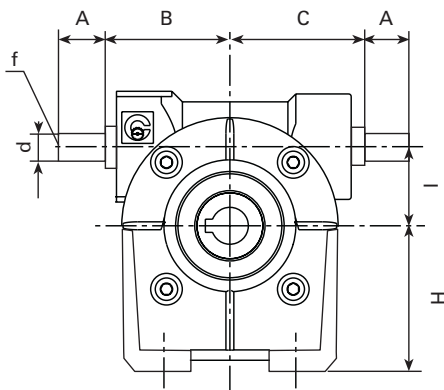

**CHBRE 06-07-08**

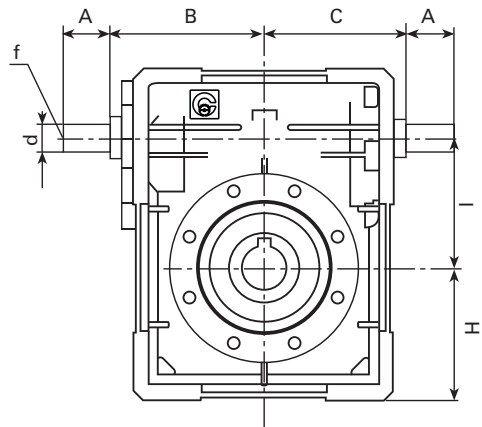

## DIMENSIONI ALBERO LENTO - OUTPUT SHAFT DIMENSIONS

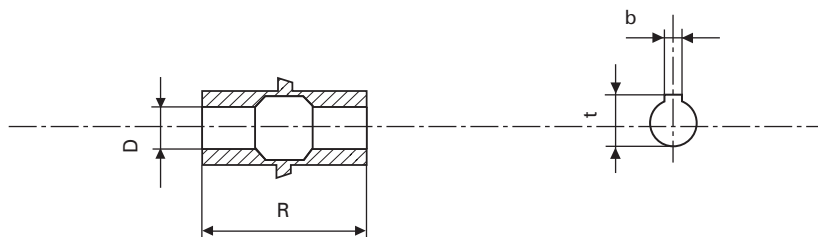

TIPO TYPE	A	B	C	D(H7)	d(h6)	f	H	I	R	b	t
CHBR 03	20	50	/	14	9	/	55	30	55	5	16.3
CHBR 04	30	54	/	18	11	/	72	44.6	64	6	20.8
CHBR 05	40	65	/	25	16	M6	82	49.5	82	8	28.3
CHBR 06	40	110.5	/	25	18	M6	72.5	62.17	120	8	28.3
CHBR 07	40	128	/	30	19	M6	87	75	127	8	33.3
CHBR 08	50	144	/	35	25	M8	100	86.9	140	10	38.8
CHBRE 03	20	50	50	14	9	/	55	30	55	5	16.3
CHBRE 04	30	54	56	18	11	/	72	44.6	64	6	20.8
CHBRE 05	40	65	65	25	16	M6	82	49.5	82	8	28.3
CHBRE 06	40	110.5	74	25	18	M6	72.5	62.17	120	8	28.3
CHBRE 07	40	128	88.5	30	19	M6	87	75	127	8	33.3
CHBRE 08	50	144	101.5	35	25	M8	100	86.9	140	10	38.3





**CHPC/CHB**

**RIDUTTORE A VITE SENZA FINE CON PRECOPPIA  
WORM GEAR WITH PRE-STAGE MODULE**

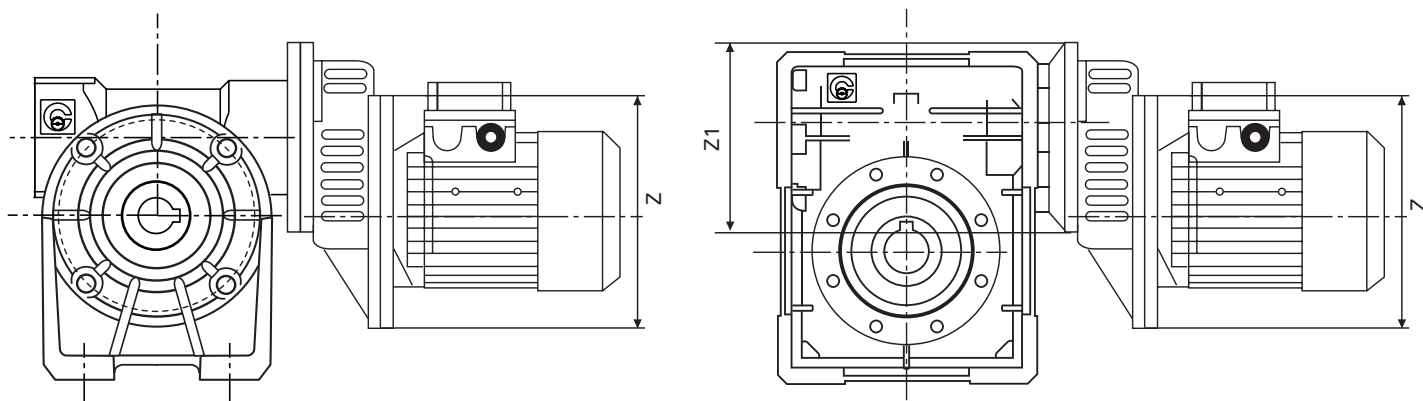

**CHPC****RIDUTTORE A VITE SENZA FINE CON PRECOPPIA  
WORM GEAR WITH PRE-STAGE MODULE**

	<b>Z</b>	<b>Z1</b>
<b>CHPC 63</b>	11/140	11/105
<b>CHPC 71</b>	14/160	14/120
<b>CHPC 80</b>	19/200	19/160

DESIGNAZIONE - DESIGNATION CHPC / CHB - CHB..P

CHPC / CHBE - CHB..P

<b>TIPO TYPE</b>	<b>GRANDEZZA SIZE</b>	<b>i =</b>	<b>P.A.M. M.M.F.</b>
<b>CHPC</b>	63	3	63B5
	71	3	71B5
	80	3	80B5

ESEMPIO ORDINE - EXAMPLE ORDER

<b>CHPC</b>	<b>71</b>	<b>CHB 05</b>	<b>i= 108(3x36)</b>	<b>P.A.M. M.M.F. 71</b>
-------------	-----------	---------------	---------------------	-------------------------

Nel caso venga richiesto anche il motore specificare:

*If the motor is also required, please specify:*

Grandezza - Size es. 71 B4

Potenza - Power es. Kw 0.37

Poli - Poles es. 4

Tensione - Voltage es. V230/400

Frequenza - Frequency es. 50 Hz



TIPO	i=ratio	n2 r/min	Kw=P1	Nm=T2
TYPE	105	13.3	0.12	42
CHPC63	138	10.1	0.12	42
CHB 04	180	7.8	0.12	46
	210	6.7	0.12	40
	300	4.7	0.12	36

TIPO	i=ratio	n2 r/min	Kw=P1	Nm=T2
CHPC71	84	16.7	0.25	80
CHB 05	108	12.9	0.25	90
	135	10.4	0.25	90

TIPO	i=ratio	n2 r/min	Kw=P1	Nm=T2
TYPE	120	11.7	0.55	280
CHPC71	150	9.3	0.37	215
CHB 07	180	7.8	0.37	235
	240	5.8	0.37	210
	300	4.7	0.25	275

TIPO	i=ratio	n2 r/min	Kw=P1	Nm=T2
CHPC71	168	8.3	0.55	350
CHB 08	192	7.3	0.37	280
	240	5.8	0.37	290
	300	4.7	0.37	275

TIPO	i=ratio	n2 r/min	Kw=P1	Nm=T2
TYPE	108	12.9	0.18	72
CHPC63	135	10.4	0.18	85
CHB 05	180	7.8	0.12	65
	210	6.7	0.12	67
	240	5.8	0.12	58
	300	4.7	0.12	56

TIPO	i=ratio	n2 r/min	Kw=P1	Nm=T2
TYPE	114	12.3	0.37	170
CHPC71	135	10.4	0.37	176
CHB 06	192	7.3	0.25	149
	240	5.8	0.25	130
	300	4.7	0.25	120

TIPO	i=ratio	n2 r/min	Kw=P1	Nm=T2
CHPC80	90	15.6	0.75	310
CHB 07	120	11.7	0.75	300
	150	9.3	0.55	260

TIPO	i=ratio	n2 r/min	Kw=P1	Nm=T2
TYPE	120	11.7	0.75	390
CHPC80	138	10.1	0.75	360
CHB 08	168	8.3	0.55	350
	192	7.3	0.55	330
	240	5.8	0.55	305

### CHPC/CHB DIMENSIONI - DIMENSIONS

#### CHPC.. /CHB 06-07-08

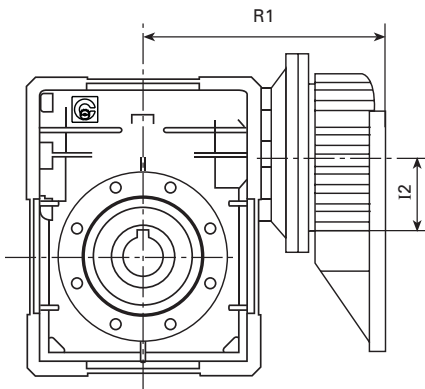

#### CHPC.. /CHB 04-05

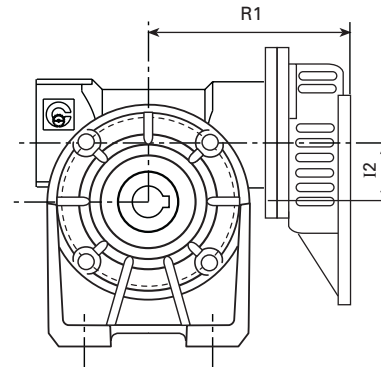

Per le altre dimensioni consultare il catalogo alle pagine 57 - 58 - 62 - 63 - 64.  
For other dimensions see pages 57 - 58 - 62 - 63 and 64 of the catalogue.

CHPC - CHB	R1	I2
63 + 04	113	40
63 + 05	118	40
71 + 05	127	50
71 + 06	158	50
71 + 07	181	50
80 + 07	197	63
71 + 08	192	50
80 + 08	208	63

La scelta delle potenze installate è legata all'unificazione dei motori, pertanto talvolta è esuberante rispetto al riduttore, nella selezione verificare sempre la coppia massima indicata, per ogni dubbio contattare il nostro ufficio tecnico.

The choice of power installed is tied to the unification of the motors, therefore it is sometimes in exuberance compared to the gear; always verify the maximum torque indicated when making the selection and if in doubt please contact our technical office.



**CHB - CHB**

**RIDUTTORE A VITE SENZA FINE COMBINATO  
DOUBLE WORM GEAR**



# CHB - CHB

# RIDUTTORE A VITE SENZA FINE COMBINATO DOUBLE WORM GEARS

DESIGNAZIONE - DESIGNATION CHB(R)/CHB - CHB(R)/CHB..P

TIPO	GRANDEZZA	VERSIONE	POS. FLANGIA (1)	i	ESEC.	P.A.M.
TYPE	SIZE	VERSION	FLANGE POS. (1)	i	EXEC.	MMF
CHB/CHB	03/04	F	1	Vedi pag. 72 Ratio see page 72	OAD	63B5
CHB/CHB..P	03/05	FA	2		OAS	63B14
CHBR/CHB		(2)			OBD	56B5
CHBR/CHB..P					OBS	56B14
					VAD	
				VAS		
				VBD		
				VBS		

TIPO	GRANDEZZA	VERSIONE	POS. FLANGIA (1)	i	ESEC.	P.A.M.
TYPE	SIZE	VERSION	FLANGE POS. (1)	i	EXEC.	MMF
CHB/CHB	03/06	FC	1	Vedi pag. 72 Ratio see page 72	OAD	71B5
CHB/CHB..P	04/07	F	2		OAS	71B14
CHBR/CHB	04/08	(3)			OBD	63B5
CHBR/CHB..P					OBS	63B14
					VAD	56B5
				VAS	56B14	
				VBD		
				VBS		

## DIMENSIONI RIDUTTORI COMBINATI CHB/CHB DIMENSIONS OF CHB/CHB COMBINED GEARS

CHB 03/CHB 04-05

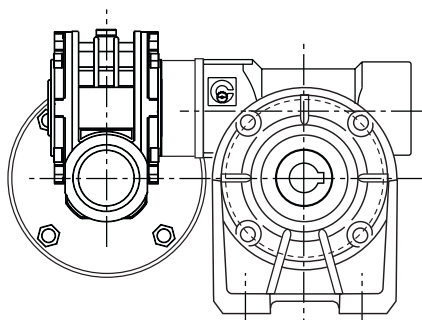

CHB 03/CHB 06

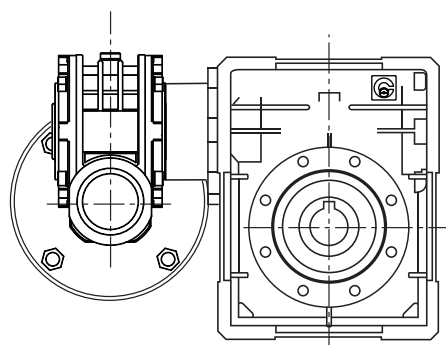

CHB 04/CHB 07-08

Per le esecuzioni vedi tabella con disegni pag.71, se non specificato vengono forniti OBS  
For the executions see the table with drawings on page 71, if not specified OBS would be supplied.

## ESEMPIO ORDINE - EXAMPLE ORDER

CHB/CHB	03/05P	FA	2	315	OBS	56B14
---------	--------	----	---	-----	-----	-------

Nel caso venga richiesto anche il motore specificare:

*If the motor is also required, please specify:*

Grandezza - Size es. 56 C4  
Potenza - Power es. Kw 0.09  
Poli - Poles es. 4  
Tensione - Voltage es. V230/400  
Frequenza - Frequency es. 50 Hz  
Flangia - Flange es. B14

1) vedi pagine 55 e 61 - see page 55 and 61

2) nessuna indicazione significa senza flangia di uscita. In questo caso il gruppo può essere con fissaggio a piedi CHB/CHB o pendolare CHB/CHB..P  
lack of instructions indicates that the gear is not equipped with an output flange. In this case the group can be fixed on feet CHB/CHB or be swinging CHB/CHB..P

3) nessuna indicazione significa senza flangia di uscita.  
lack of instructions indicates that the gear is not equipped with an output flange.

## ESECUZIONE - EXECUTION

OAD

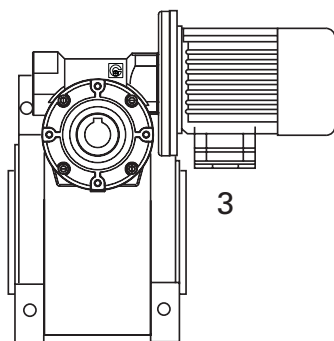

OAS

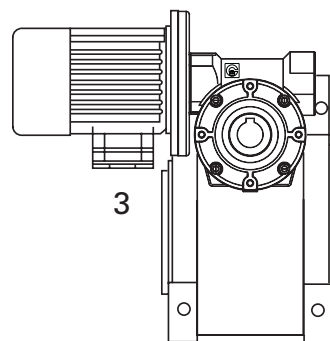

OBD

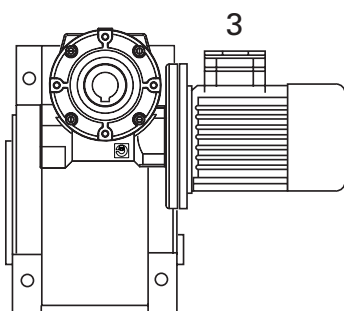

OBS

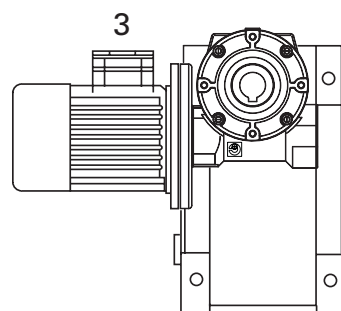

VAD

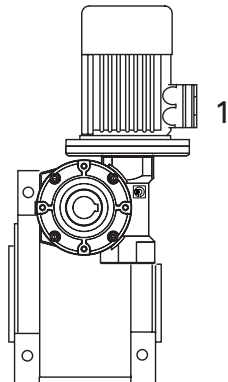

VAS

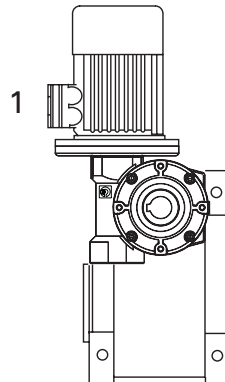

VBS

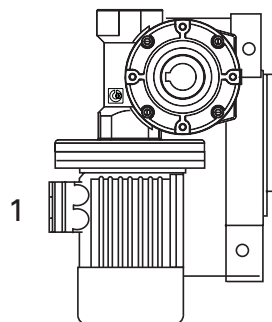

VBD

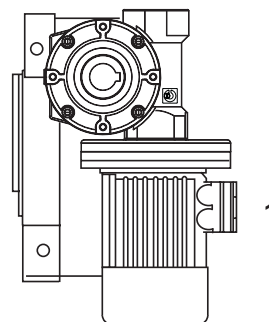

L'esecuzione determina la posizione di montaggio del 1° riduttore rispetto al 2° riduttore. Se non diversamente specificato in fase d'ordine il gruppo viene fornito in esecuzione OBS. La posizione di piazzamento va riferita al 2° riduttore.

The execution determines the mounting position of the first gear in relation to the second gear. If not otherwise specified at the time of order, the group will be supplied in the OBS execution. The placing position refers to the second gear.



TIPO	i=ratio	n2 r/min	Kw=P1	Nm=T2
TYPE	245	5.7	0.09	58
	350	4.0	0.09*	58
	420	3.3	0.09*	58
CHB	560	2.5	0.09*	58
03/04	700	2.0	0.09*	58
	840	1.7	0.09*	58
	1120	1.3	0.09*	58
	1680	0.8	0.09*	58
	2100	0.7	0.09*	58
	2760	0.5	0.09*	50

TIPO	i=ratio	n2 r/min	Kw=P1	Nm=T2
TYPE	240	5.8	0.12	77
	315	4.4	0.12	90
	420	3.3	0.09	90
CHB	540	2.6	0.09	90
03/05	720	1.9	0.09*	90
	900	1.6	0.09*	90
	1120	1.3	0.09*	90
	1440	0.9	0.09*	90
	2160	0.6	0.09*	90
	2700	0.5	0.09*	90

TIPO	i=ratio	n2 r/min	Kw=P1	Nm=T2
TYPE	240	5.8	0.22	160
	315	4.4	0.22	180
	450	3.1	0.18	200
CHB	570	2.5	0.12	180
03/06	720	1.9	0.12	200
	900	1.6	0.12	200
	1200	1.2	0.12	200
	1520	0.9	0.09*	200
	2280	0.6	0.09*	200
	2700	0.5	0.09*	200

TIPO	i=ratio	n2 r/min	Kw=P1	Nm=T2
TYPE	250	5.6	0.37	360
	300	4.7	0.37	360
	400	3.5	0.25	315
CHB	525	2.7	0.25	360
04/07	700	2.0	0.18	360
	920	1.5	0.18	360
	1200	1.2	0.12	360
	1500	0.93	0.12*	360
	2100	0.67	0.12*	360
	2800	0.5	0.12*	360

TIPO	i=ratio	n2 r/min	Kw=P1	Nm=T2
TYPE	230	5.6	0.55	460
	300	4.7	0.55	490
	400	3.5	0.55	490
CHB	525	2.7	0.37	490
04/08	700	2.0	0.37	490
	920	1.5	0.25	490
	1380	1.2	0.18	490
	1840	0.93	0.18	490
	2116	0.67	0.12	490
	2760	0.5	0.12	490

\* Le potenze contrassegnate sono superiori a quelle ammissibili dal riduttore, pertanto la scelta applicativa dovrà essere fatta in funzione della coppia e non della potenza.

\* The powers marked with an asterisk are higher than those that the gear allows, therefore the applicative choice must be made in accordance with the torque and not with the power.

### DIMENSIONI RIDUTTORI COMBINATI CHB/CHB DIMENSIONS OF CHB/CHB COMBINED GEARS

CHB 03/CHB 04-05

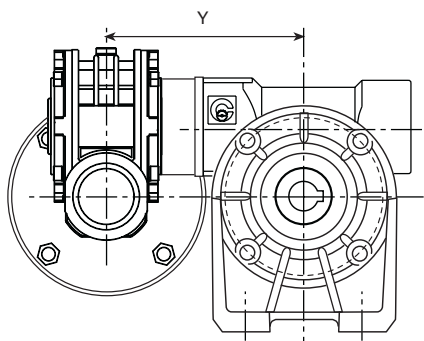

CHB 03/CHB 06 CHB 04/CHB 07-08

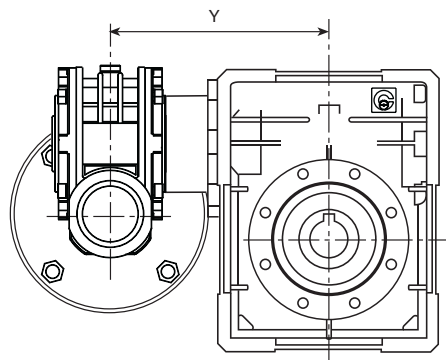

	Y
CHB 03/04	120.5
CHB 03/05	125.5
CHB 03/06	165
CHB 04/07	192
CHB 04/08	204.5

Per le altre dimensioni consultare il catalogo alle pagine 56-57-58-62-63 e 64.  
For other dimensions see pages 56-57-58-62-63 and 64 of the catalogue.

I rapporti di riduzione indicati sono quelli maggiormente richiesti, è possibile ottenere molteplici combinazioni utilizzando i vari rapporti dei due singoli riduttori.

The gear ratios are those most frequently requested. It is possible to obtain multiple combinations using the various ratios of the two single gears.



## BRACCIO DI REAZIONE - TORQUE ARM

TIPO TYPE	I	A	B	Ø P	Ø C	Ø d	H	øE	S
CHB 03	100	40	157.5	50	65	7	14	8	4
CHB 04	100	40	157.5	50	65	7	14	8	4
CHB 05	100	55	172.5	68	94	7	14	8	4
CHB 06	150	52.5	232.5	75	90	9	20	10	6
CHB 07	200	62.5	300	90	110	9	25	20	6
CHB 08	200	75	312.5	110	130	11	25	20	6

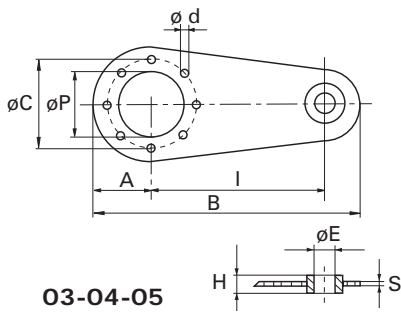

03-04-05

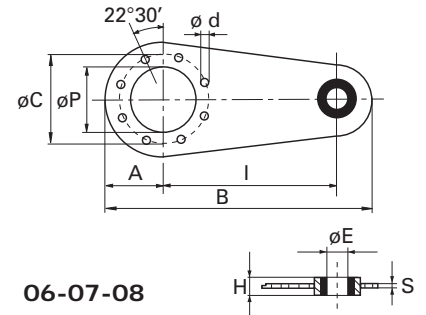
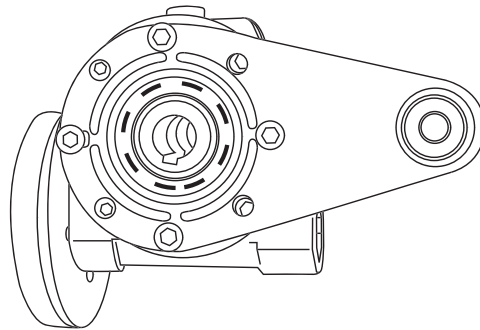

06-07-08

\* Privo di boccola antivibrante  
\* Without anti vibration bush

Il punto di ancoraggio del braccio di reazione è dotato di boccola antivibrante.

The anchoring point of the torque arm is equipped with a vibration resistant bushing.

## KIT ALBERO LENTO SEMPLICE - SINGLE OUTPUT SHAFT KIT

TIPO TYPE	A	Ø d	B	b	t1	T	L	d2	ød1
CHB 03	30	14	35	5	16	61	96	M5x13	14
CHB 04	40	18	45	6	20.5	70	115	M6x16	18
CHB 05	60	25	65	8	28	89	154	M8x20	25
CHB 06	60	25	65	8	28	127	192	M8x20	25
CHB 07	60	30	65	8	33	134	199	M10x22	30
CHB 08	60	35	65	10	38	149	214	M10x25	35

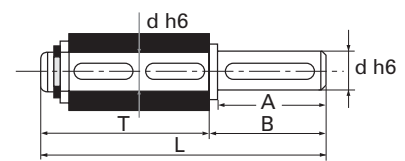
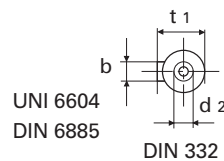

## KIT ALBERO LENTO DOPPIO - DOUBLE OUTPUT SHAFT KIT

TIPO TYPE	A	Ø d	B	R	b	t1	L	d2	ød1
CHB 03	30	14	32.5	55	5	16	120	M5x13	14
CHB 04	40	18	42.7	64	6	20.5	149.4	M6x16	18
CHB 05	60	25	63.2	82	8	28	208.4	M8x20	25
CHB 06	60	25	63.2	120	8	28	246.4	M8x20	25
CHB 07	60	30	64	127	8	33	255	M10x22	30
CHB 08	60	35	64	140	10	38	268	M10x25	35

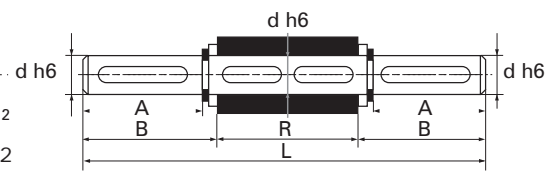
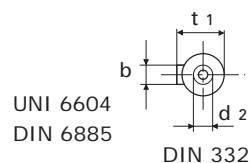



# COPRIMOZZO CORONA - COVER

CHB 03-04-05

CHB 06-07-08

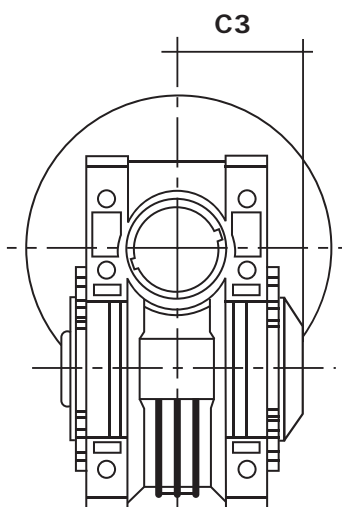
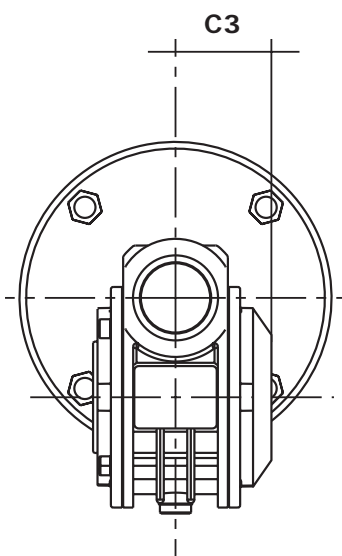

TIPO	TYPE	C3
03		37
04		42
05		55
06		70
07		85,5
08		93,5

## KIT BOCCOLE DI RIDUZIONE - REDUCTION BUSHINGS KIT

### SEMPLICE - SINGLE

TIPO TYPE	$\varnothing i / \varnothing e$ $\varnothing i / \varnothing e$	L L	linguette tongues	Peso cad kit kg Weight for kit kg
CHT BRM-S	9/11	20	4/3 x 4 x 11 RB*	0.006
CHT BRM-S	11/14	30	5/4 x 6 x 10 RB*	0.015
CHT BRM-S	14/19	40	6 x 5 x 30 *	0.045
CHT BRM-S	19/24	50	6 x 5.5 x 20 * 8 x 5.5 x 40 *	0.07
CHT BRM-S	24/28	60	8 x 9 x 40 *	0.08
CHT BRM-S	28/38	80	10 x 7 x 60 *	0.33
CHT BRM-S	38/42	110	12/10 x 10 x 48 RB*	0.22

### DOPPIO - DOUBLE

TIPO TYPE	$\varnothing i / \varnothing e$ $\varnothing i / \varnothing e$	L L	linguette tongues	Peso cad kit kg Weight for kit kg
CHT BRM-D	11/19	40	6 x 6 x 30 *	0.06
CHT BRM-D	14/24	50	8 x 7 x 40 A	0.12
CHT BRM-D	19/28	60	8 x 7 x 50 A	0.16
CHT BRM-D	24/38	80	10 x 8 x 60 A	0.44

\* a disegno  
\* to drawing

Linguetta sec UNI 6604 - DIN 6885  
Bonificate

Tongue acc. to UNI 6604 - DIN 6885  
Quenched

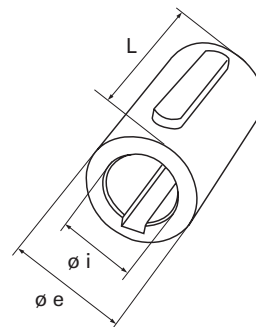
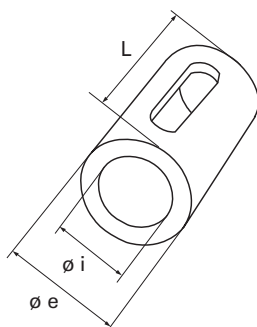

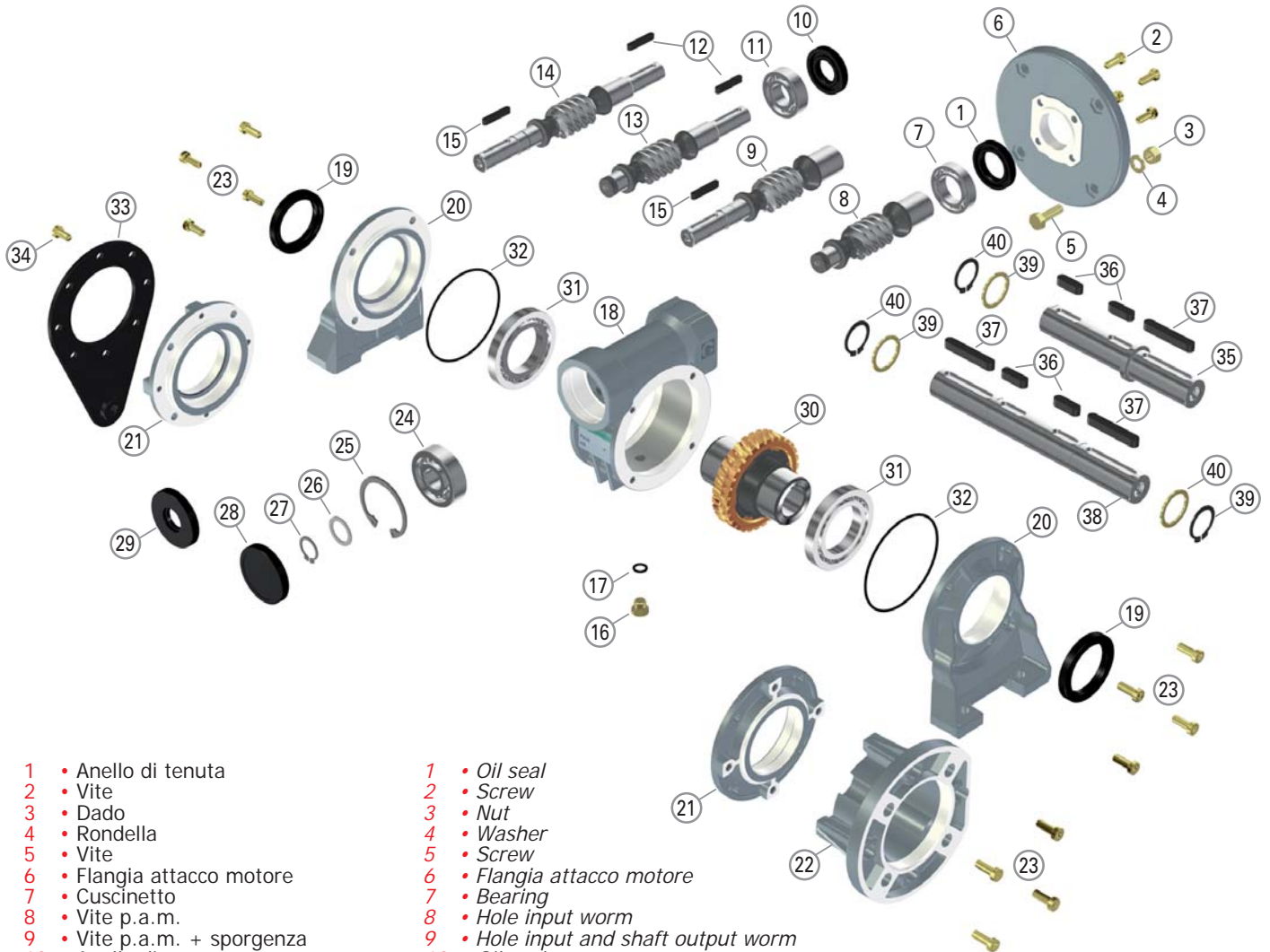

- 1 • Anello di tenuta
- 2 • Vite
- 3 • Dado
- 4 • Rondella
- 5 • Vite
- 6 • Flangia attacco motore
- 7 • Cuscinetto
- 8 • Vite p.a.m.
- 9 • Vite p.a.m. + sporgenza
- 10 • Anello di tenuta
- 11 • Cuscinetto
- 12 • Chiavette
- 13 • Vite sporgente
- 14 • Vite bisporgente
- 15 • Chiavetta
- 16 • Tappo olio
- 17 • Guarnizione
- 18 • Cassa
- 19 • Anello di tenuta
- 20 • Coperchio con piedi
- 21 • Coperchio pendolare
- 22 • Flangia uscita
- 23 • Vite
- 24 • Cuscinetto
- 25 • Seeger
- 26 • Distanziale
- 27 • Seeger
- 28 • Cappellotto
- 29 • Anello di tenuta
- 30 • Corona
- 31 • Cuscinetto
- 32 • O-ring
- 33 • Braccio di reazione
- 34 • Vite
- 35 • Albero lento semplice
- 36 • Chiavetta
- 37 • Chiavetta
- 38 • Albero lento doppio
- 39 • Distanziale
- 40 • Seeger

- 1 • Oil seal
- 2 • Screw
- 3 • Nut
- 4 • Washer
- 5 • Screw
- 6 • Flangia attacco motore
- 7 • Bearing
- 8 • Hole input worm
- 9 • Hole input and shaft output worm
- 10 • Oil seal
- 11 • Bearing
- 12 • Key
- 13 • Shaft input worm
- 14 • Double extended input shaft worm
- 15 • Key
- 16 • Oil plug
- 17 • Gasket
- 18 • Casing
- 19 • Oil seal
- 20 • Foot cover
- 21 • Side cover
- 22 • Output flange
- 23 • Screw
- 24 • Bearing
- 25 • Seeger
- 26 • Spacer
- 27 • Seeger
- 28 • Cap
- 29 • Oil seal
- 30 • Worm wheel
- 31 • Bearing
- 32 • O-ring
- 33 • Braccio di reazione
- 34 • Screw
- 35 • Single output shaft
- 36 • Key
- 37 • Key
- 38 • Double output shaft
- 39 • Spacer
- 40 • Seeger



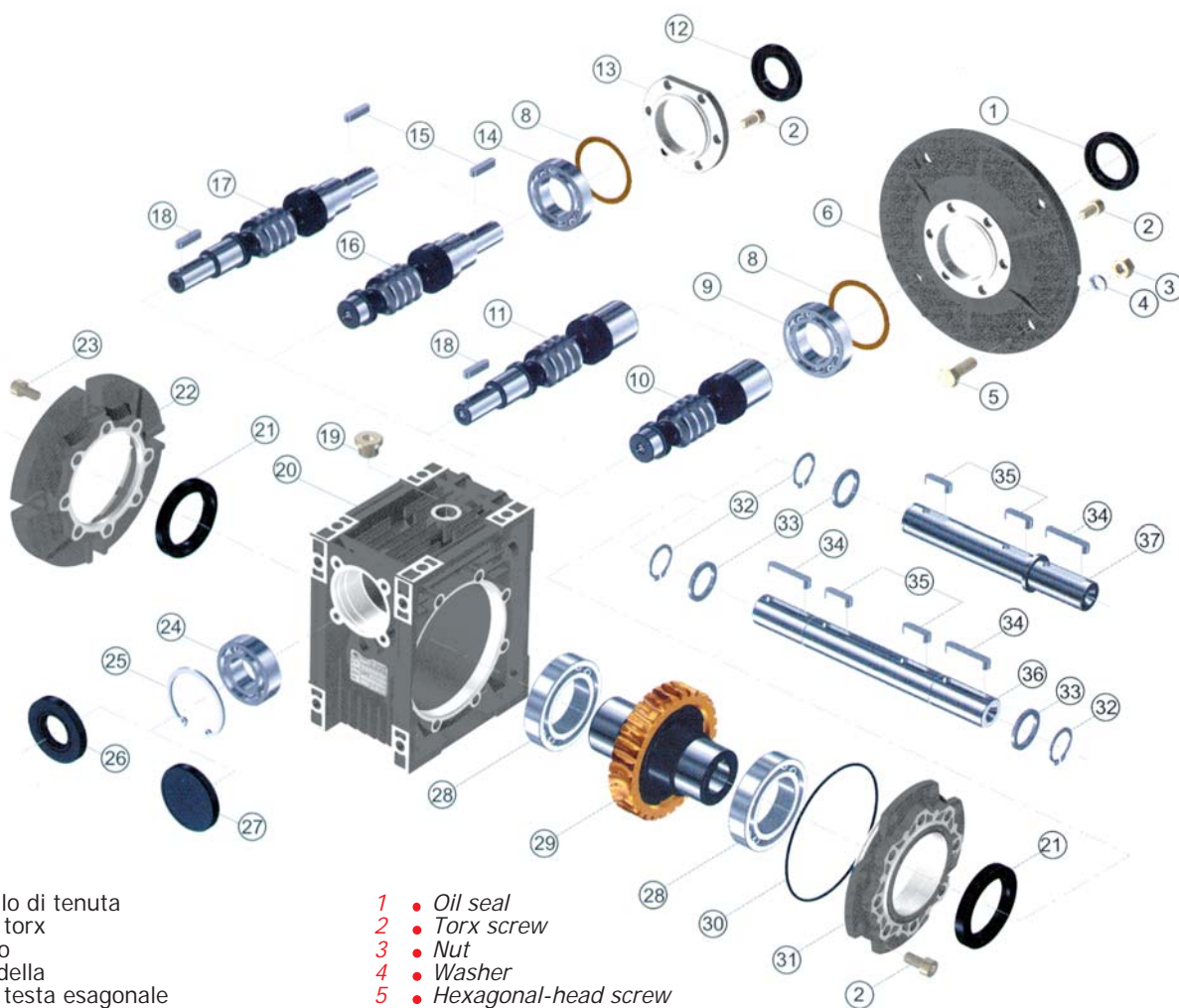

- 1 • Anello di tenuta
- 2 • Vite torx
- 3 • Dado
- 4 • Rondella
- 5 • Vite testa esagonale
- 6 • Flangia attacco motore
- 8 • Rasamento
- 9 • Cuscinetto
- 10 • Vite p.a.m.
- 11 • Vite p.a.m. + sporgenza
- 12 • Anello di tenuta
- 13 • Coperchio entrata
- 14 • Cuscinetto
- 15 • Chiavetta
- 16 • Vite sporgente
- 17 • Vite bisporgente
- 18 • Chiavetta
- 19 • Tappo olio
- 20 • Cassa
- 21 • Anello di tenuta
- 22 • Flangia uscita
- 23 • Vite testa esagonale incassata
- 24 • Cuscinetto
- 25 • Seeger
- 26 • Anello di tenuta
- 27 • Cappello
- 28 • Cuscinetto
- 29 • Corona
- 30 • O-ring
- 31 • Coperchio uscita
- 32 • Seeger
- 33 • Distanziale
- 34 • Chiavetta
- 35 • Chiavetta
- 36 • Albero lento doppio
- 37 • Albero lento semplice

- 1 • Oil seal
- 2 • Torx screw
- 3 • Nut
- 4 • Washer
- 5 • Hexagonal-head screw
- 6 • Motor connection flange
- 8 • Adjust spacer
- 9 • Bearing
- 10 • Hole input worm
- 11 • Hole input and shaft output worm
- 12 • Oil seal
- 13 • Input cover
- 14 • Bearing
- 15 • Key
- 16 • Shaft input worm
- 17 • Double extended input shaft worm
- 18 • Key
- 19 • Oil plug
- 20 • Casing
- 21 • Oil seal
- 22 • Output flange
- 23 • Embedded hexagonal-head screw
- 24 • Bearing
- 25 • Seeger
- 26 • Oil seal
- 27 • Cap
- 28 • Bearing
- 29 • Worm wheel
- 30 • O-ring
- 31 • Output cover
- 32 • Seeger
- 33 • Spacer
- 34 • Key
- 35 • Key
- 36 • Double output shaft
- 37 • Single output shaft



I carichi indicati valgono in qualunque direzione di applicazione.

I carichi assiali massimi ammissibili sono pari a 1/5 del valore del carico radiale indicato in tabella quando sono applicati in combinazione con il carico radiale stesso, in caso diverso vi preghiamo di contattare il ns. ufficio tecnico.

Se vengono utilizzati alberi lenti doppi, la somma dei carichi radiali applicabili alle mezzerie delle due estremità d'albero, non devono superare il valore indicato nella tabella sottoindicata.

I carichi radiali riferiti ai giri di uscita (n2)=10 sono i massimi sopportabili dal riduttore.

*The loads indicated are valid for all application directions.*

*The maximum allowable axial loads are equal to 1/5 of the radial load value shown in the table when applied with the same radial load; if this is not the case, please contact our technical office. If double output shafts are used, the sum of radial loads applicable to the centre lines of the two ends of the shaft must not exceed the value shown in the table below.*

*The radial loads related to the output speed (n2)=10 are the maximum loads supported by the gear.*

- a • Costante del riduttore
- b • Costante del riduttore
- x • Distanza del carico dalla battuta dell'albero in mm.
- FRx • Carico radiale nella posizione x (in N)
- FR • Carico radiale (N)
- FA • Carico assiale (N)

- a • Gear constant
- b • Gear constant
- x • Load distance from shaft shoulder in mm.
- FRx • Radial load in position x (in N)
- FR • Radial load (N)
- FA • Axial load (N)

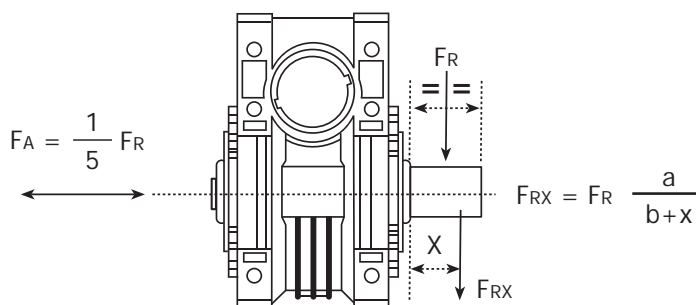

**GRANDEZZE - SIZES**

Giri di uscita Output speed	03	04	05	06	07	08
400	490	720	1000	1450	1800	2020
250	580	860	1190	1720	2140	2420
150	690	1010	1400	2020	2510	2840
100	790	1160	1600	2330	2880	3260
60	940	1380	1910	2770	3440	3880
40	1070	1570	2160	3130	3890	4380
25	1260	1850	2550	3700	4590	5180
10	1700	2500	3450	5000	6200	7000

**VALORI DELLE COSTANTI - CONSTANTS' VALUES**

a	60	71	99	130	136	146
b	45	51	69	102	108	118



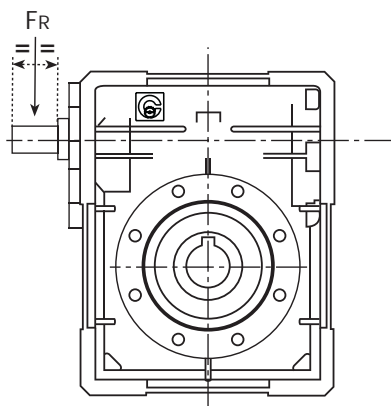

## GRANDEZZE - SIZES

	03	04	05	06	07	08
<b>Fr max</b>	100	150	220	700	975	1150

Note: i valori delle tabelle sono espressi in N

Notes: value of tables are in N

**INSTALLAZIONE**

- I dati riportati sulla targhetta identificativa devono corrispondere al riduttore ordinato.
- Tutti i riduttori vengono forniti completi di olio sintetico permanente in quantità idonea a qualsiasi posizione di montaggio.
- Il fissaggio del riduttore deve avvenire su superfici piane e sufficientemente rigide in modo da evitare qualsiasi vibrazione.
- Il riduttore e l'asse della macchina da movimentare devono essere in perfetto allineamento.
- In caso si prevedano urti, sovraccarichi o blocchi della macchina il cliente dovrà provvedere all'installazione di limitatori, giunti, salvamotori etc.
- Gli accoppiamenti con pignoni, giunti, pulegge ed altri organi devono essere fatti previa pulizia delle parti ed evitando urti nel montaggio poiché questo potrebbe danneggiare i cuscinetti ed altre parti interne.
- Nel caso il motore sia di fornitura del cliente questi dovrà accertarsi che le tolleranze di flangia ed albero corrispondono ad una classe "normale", i nostri motori rispondono a questa esigenza.
- Verificare che le viti di fissaggio del riduttore e dei relativi accessori siano correttamente serrate.
- Adottare gli opportuni accorgimenti per proteggere i gruppi da eventuali agenti atmosferici aggressivi.
- Dove previsto proteggere le parti rotanti da possibili contatti con gli operatori.
- Nel caso i riduttori vengano verniciati proteggere gli anelli di tenuta ed i piani lavorati.
- Tutti i riduttori sono verniciati colore grigio RAL 9022.

**FUNZIONAMENTO E RODAGGIO**

- Per ottenere le migliori prestazioni è necessario provvedere ad un adeguato rodaggio dei riduttori incrementando la potenza gradualmente nelle prime ore di funzionamento, in questa fase un aumento delle temperature è da considerarsi nella norma.
- In caso di funzionamento difettoso, rumorosità, perdite olio etc. arrestare immediatamente il riduttore e, dove possibile, rimuovere la causa, in alternativa inviare il pezzo alla nostra sede per i controlli.

**MANUTENZIONE**

- I riduttori a vite senza fine dalla grandezza 03 alla grandezza 08 e le precoppie sono lubrificate con olio sintetico permanente, pertanto non richiedono alcuna manutenzione.

**CONSERVAZIONE A MAGAZZINO**

- Nel caso di lunga conservazione a magazzino, superiore a tre mesi, si consiglia di proteggere alberi e piani lavorati con antiossidanti e di ingrassare gli anelli di tenuta.

**MOVIMENTAZIONE**

- Nella movimentazione dei gruppi dovrà essere posta molta attenzione a non danneggiare gli anelli di tenuta ed i piani lavorati.

**SMALTIMENTO IMBALLI**

- Gli imballi in cui vengono consegnati i nostri riduttori andranno avviati, dove possibile, al riciclo degli stessi tramite le ditte preposte.

**INSTALLATION**

- *The data shown on the identification name plate must correspond to the gear ordered.*
- *All the gears are supplied complete with permanent synthetic oil in a quantity that is sufficient for any assembly position.*
- *The gear must be fixed on a flat surface that is sufficiently rigid in order to avoid any vibration.*
- *The gear and the axis of the machine to be driven must be perfectly aligned.*
- *In the event that knocks, overloading or blockage of the machine are foreseen, the client must install a limiting device, joints, overload cut-out etc.*
- *Coupling with pinions, joints, pulleys and other parts must be done after the parts have been cleaned and knocks should be avoided whilst assembling as they could damage the bearings and other internal parts.*
- *In the event that the motor is supplied by the client, he must check that the flange and shaft tolerances correspond to a "normal" class; our motors satisfy this requirement.*
- *Check that the fixing screws for the gear and the related accessories are correctly tightened.*
- *Take suitable measures to protect the groups from any aggressive atmospheric agents.*
- *Where foreseen, protect rotating parts from any possible contact with the operators.*
- *If the gears are painted, protect the oil seals and the machined surfaces.*
- *All of the gears are painted RAL 9022 grey.*

**OPERATION AND RUNNING-IN**

- *To obtain the best performance the gears must first be run-in by gradually increasing the power in the first few hours of operation, in this phase an increase in temperature is considered normal.*
- *In the event of defective operation, noise, oil leakage, etc. stop the gear immediately and, when possible, remove the cause. Alternatively, send the piece to our factory to be controlled.*

**MAINTENANCE**

- *The worm gears from size 03 to size 08 and the pre-stage modules are lubricated with permanent synthetic oil and therefore do not require any maintenance.*

**WAREHOUSE STORAGE**

- *If the warehouse storage will be for a long time, more than 3 months, the shafts and machined surfaces should be protected using antioxidants and the oil seals should be greased.*

**HANDLING**

- *Care must be taken not to damage the oil seals and the machined surfaces when handling the groups.*

**DISPOSAL OF PACKAGING**

- *The packaging in which our gears are delivered should be sent to specialised companies for recycling if possible.*